





Genuine Yamaha parts and accessories. Why choose anything else?

Yamaha is a name synonymous with performance, quality and reliability - and behind it is a reputation earned from years of creating outboard engines and marine products which incorporate the most advanced and innovative technology. In fact, millions of water sports enthusiasts and professionals the world over choose Yamaha, simply because it's the name they know and trust - and because they know we apply the very same high standards and attention to detail to everything we make. So it's no surprise that they also choose Yamaha when it comes to their parts and accessories. What's more, all our products are designed to work seamlessly with each other, which means not just co-ordinated design, looks and styling, but more dependable performance and a comforting feeling of peace of mind.

There's an impressively wide range too, extending from exciting watersport accessories, smart steering wheels and high-performance props - to hi-tech marine lubricants, ingenious security locks and protective covers for engines and watercraft. Not to mention remote controls and steering systems, switches, filters, fuel tanks and other practical things! Check out too, our line-up of Digital Network Gauges and electronic control systems - with its integral, centrally-managed system of command and control, comes a revolution in boating comfort and enjoyment.

So whatever you may need to enhance your fun and enjoyment on the water, we've got it covered - with products that are designed to perform and built to last. Just as you'd expect from Yamaha.



What's New?	2	
Propellers		
Propeller Information	4	
Series description	5	
Selection guide by model	7	
Outboard Rigging & Accessories		
Helm Master	16	
Instruments	18	
Remote controls	22	
Switch panels	28	
Rigging Kits	30	
Harnesses	36	
Tiller handle	39	
YCOP & accessories	40	
Steering & Steering Systems	41	
Filters & Fuel Accessories	44	
Other Rigging & Accessories	47	
Anodes, Impellers, Thermostats	54	
Fuel & Oil Filters, Spark Plugs	55	
Rigging Order Guide	58	
Yamalube	80	
WaveRunner Accessories	95	
Apparel		
Casual wear	98	
Accessories	105	
Fun on the Water	108	

F150D (2015)



F130A (2015)



F8F / FT8G (2015)



See our 2016 Outboards catalogue for full details

NEW RIDE SYSTEM (2015)



An all new, intuitive and revolutionary driving experience

NEW TR-1 ENGINE (2016)



NEW VX CRUISER (2016)



See our 2016 WaveRunner catalogue for full details

HELM MASTER

Yamaha's first fully integrated boat control system
See page 16



NEW K SERIES TALON STAINLESS STEEL PITCH (WITH SDS)

Combine quiet, clunk-free shifting and smooth in-gear operation.
See pages 5 & 9



NEW WAVERUNNER COVERS

See page 96



NEW WETSUITS AND TOWABLES LINE-UP

See page 108
Availability: Summer 2016



NEW 6YC DIGITAL GAUGE

See page 19



NEW TRAILER SUPPORT

See page 50



NEW 60TH ANNIVERSARY COLLECTION

See page 102

Propellers and Propeller Accessories



PROPELLER INFORMATION

THE PROPELLER MAKES ALL THE DIFFERENCE.

If you haven't tried one of Yamaha's comprehensive range of propeller solutions, you're not getting the most out of your outboard. In fact, the right Yamaha propeller can maximize your outboard's acceleration, top speed, fuel economy and lifespan, all while providing a quieter ride and better handling. No matter what your application, there's a genuine Yamaha propeller that can help you achieve peak performance.

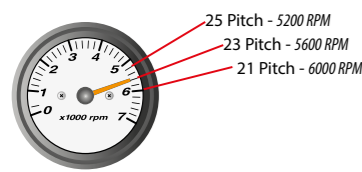

PITCH

Pitch is the 'theoretical' distance (in inches) a propeller would travel in one full revolution, if it were travelling through solid matter. A prop with low pitch will deliver better acceleration/hole shot and pushing power but a lower top speed, while a higher pitch prop will provide less thrust, but with a higher top speed. The correct propeller will allow your engine to reach the upper portion of the W-O-T range specified by the manufacturer with a normal-to-heavy load, but without exceeding it. Each inch of pitch is equal to approximately 150 +/- 50 RPM.

DIAMETER

Diameter means the total width of the "circle" at the blade tips as the propeller spins. Larger diameter props push more water and reach deeper down into the water, so they're typically used on large, heavy boats or ones with higher-placed engine mountings. A smaller diameter prop is usually used on lighter boats, where the prop operates closer to the surface of the water - or when you need a higher engine RPM.

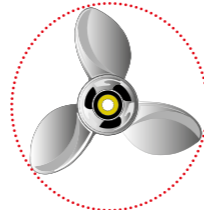

NUMBER OF BLADES

Three-bladed propellers are the most common, offering good overall performance, top speed, and efficiency for most applications. While a four-bladed prop will provide increased bow and stern-lift and reduce prop ventilation, this normally means more drag on the engine, resulting in lower top speeds and different handling characteristics.

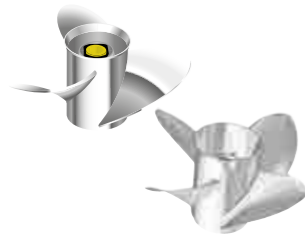

BLADE GEOMETRY

Blade geometry refers to the actual shape of the blade (or ear). By manipulating the blade's shape, diameter and pitch progression, different performance characteristics can be created for each different type and style of propeller.

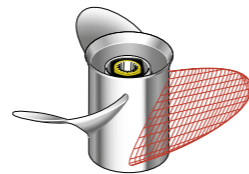

BLADE SURFACE AREA

Blade surface area refers to the total surface of the blades. The greater the blade surface area, the more water the prop pushes, for better hole shot and increased planing efficiency. However, too much blade area can create significantly more drag, potentially restricting engine RPM and causing negative boat-handling issues.

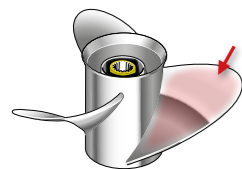

CUP

Cup is the small curved lip on the blade tip and/or trailing edge. Used in proper amounts, cup helps reduce ventilation and propeller slippage, allowing for higher engine mounting and greater bow lift. However, too much cup may cause excessive steering torque and bow lift - and limit the engine's ability to develop and maintain proper RPM at a certain pitch.

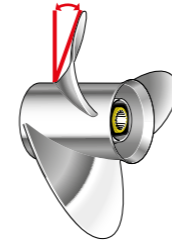
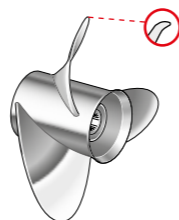

RAKE

Rake is the angle of the blade in relation to the propeller's barrel, or centre, and is expressed in degrees. A high rake propeller is best suited to applications where the engine is mounted high, to help reduce ventilation and increase bow lift. However, too much rake can strain the engine, decrease hole shot and produce negative performance and handling results. A propeller with a low rake angle will cause less strain on the engine, resulting in potentially better hole shot and higher operating rpm at W-O-T.

SDS - SHIFT DAMPENING SYSTEM

Reducing the annoying shift shock and noise normally associated with moving between gears, Yamaha's unique Shift Dampening System (SDS) uses a splined aft washer and a splined rubber hub to absorb noise and vibration. This carefully engineered solution brings smoother, quieter gear shifts.

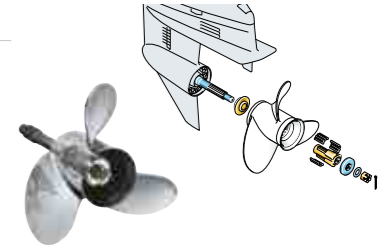

PROPELLER SERIES

ALUMINUM/PLASTIC SERIES

Offering Yamaha design, quality and performance in a low-cost, lightweight propeller, this is a good all-around choice for your Yamaha outboard. Available in a wide variety of sizes and pitches for Yamaha outboards between 2 and 225 horse power, in right-hand and select left-hand rotation.



DUAL THRUST SERIES

Specially designed for sailboats and other large-displacement craft, Yamaha's patented Dual Thrust propellers are built to handle the job of pushing heavy loads through water. The hub is carefully designed to redirect exhaust flow away from the blades, so Dual Thrust models cut through "clean water" for higher efficiency and better acceleration. It is recommended that you contact an authorised Yamaha Dealer for advice on installation.



TALON SERIES (WITH SDS)

Specially engineered to reduce ventilation and enhance bow lift, Yamaha's TALON aluminum 3-bladed propellers offer excellent holding power in turns, with enhanced "grip" for improved control. In addition, they feature better overall performance and greater cruising efficiency in a planed trim position than conventional 3-bladed aluminum propellers. TALON props are especially effective on mid-sized deep- and mod-V aluminum boats, particularly in applications with the potential for aerated water beneath the boat. The new Yamaha SDS mechanism is integrated to reduce shifting vibration and noise. Can be used with standard spacer.



K SERIES TALON STAINLESS STEEL (WITH SDS)

K-Series Talon Stainless Steel SDS propellers combine quiet, clunk-free shifting and smooth in-gear operation (even at low speeds) with a high-performance, good looking stainless steel propeller - a first for mid-range horsepower outboards. Now, medium-sized Aluminum, FRP and RIB boats using Yamaha's F70 up through to the all-new F130A can enjoy the unbeatable combination of smooth and quiet operation with great all-around performance. Just as the Talon Aluminum series, this SDS hub system requires no special hardware to operate.



BLACK STAINLESS STEEL SERIES

An excellent general-purpose choice, these props are made from stainless steel, with a cost-effective black paint coating, allowing for a blade that is thinner, more efficient and more durable than an aluminum propeller. Available in a wide variety of sizes and pitches for Yamaha outboards between 25 and 300 horse power, in right-hand and select left-hand rotation.





PERFORMANCE SERIES - 3 BLADES

A proven performer across a wide range of Yamaha outboard-powered boat applications. Highly-polished stainless steel and advanced blade design offer both good looks and good performance. Available in a wide variety of sizes and pitches for Yamaha outboards between 20 and 225 horsepower, in right-hand and select left-hand rotation.



PERFORMANCE SERIES - 4 BLADES

The four bladed design improves hole shot, acceleration, and overall "grip" and gives better performance in rough water or with higher-positioned engine mounting.



PRO SERIES

An excellent performance-oriented choice for single-engined, high-speed boats requiring "bow lift" - such as mid-to large-sized bass, bay and flats boats. Available for K and M series Yamaha outboards. Right-hand rotation only.



RELIANCE SERIES (WITH SDS)

Reliance is CAD-designed to increase performance. Designed primarily for use with Yamaha's F150 and F200 in-line 4 outboards, it also provides excellent all-around performance. Faster at all RPM ranges and having better anti-ventilation characteristics (grip) in most applications than Yamaha's proven Black Stainless Steel props, Reliance Series props are highly-polished stainless steel, featuring impressive cast-in naming on the barrel and excellent corrosion resistance. Now available with Yamaha's exclusive Shift Dampener System (SDS).



SALTWATER SERIES II (WITH SDS)

A powerful choice for today's larger offshore boats, Saltwater Series II propellers are a highly-polished, larger diameter design. Aggressive rake and extra cupping on the blades provide superior midrange fuel efficiency, along with excellent anti-ventilation characteristics. For offshore fishermen, that translates to longer cruising range and better handling in rough seas. Also available with the Yamaha Shift Dampener System (SDS).



SALTWATER SERIES HS4 (WITH SDS)

A polished stainless steel propeller with 4 blades, for certain V6 4-stroke engines. Compared with the conventional 3-bladed propeller, the 4-blade configuration has a larger blade surface area, which can catch much more water and obtain higher thrust performance. As a result, this propeller will obtain better acceleration and be more stable in operation under rough water. However, top speed performance is generally slightly less than a 3-blade design. L/H rotation propellers are available.



SALTWATER SERIES XL

A premium prop designed exclusively for the V8 5.3L 4-stroke Yamaha outboards. Designed to harness the awesome power of these engines and convert it into massive amounts of thrust, Saltwater XL propellers have more diameter and 21% more blade area than even our largest Saltwater Series II propellers. This helps the F350 generate up to 45% more thrust than other 250hp-class outboards, and provides large offshore boats with plenty of power to plane quickly, as well as great acceleration and top-end speed. Available with the SDS Shift Dampening System. (Note: deduct two inches of pitch for same or similar performance when converting non-SDS XL propellers to SDS-equipped Saltwater Series XL propellers.)



SALTWATER SERIES XL4 AND XL4-HP (WITH SDS)

Designed exclusively for Yamaha's V8 5.3L F350 outboard, this 4 bladed prop offers incredible thrust and quick-on-the-plane capability, yet with quiet and smooth operation thanks to Yamaha's unique SDS Shift Dampener System. Two XL4 prop types are available: XL4 (15" and 17") designed for very large, heavy offshore boats - and the XL4-HP (22" and 24") designed for lighter, high-performance multi-engined offshore boats.



ALUMINUM SERIES

Outboard Model	Part Number	Diameter	Pitch	Blade	Hub	Rotation	Price	Remark
2A/2B/2C	6A1-45943-00-00	7 1/4	4	3	A	RH		
	646-45944-01-00	7 1/4	4 1/2	3	A	RH		
	6F8-45942-01-00	7 1/4	5	3	A	RH		
	646-45942-01-00	7 1/4	5 1/2	3	A	RH		
F2,5A 3A	6L5-45949-00-00	7 1/4	5	3	BS	RH		
	6L5-45952-00-00	7 1/2	5 1/2	3	BS	RH		
	6L5-45943-00-00	7 1/4	6	3	BS	RH		
	6L5-45945-00-00	7 1/4	7 1/4	3	BS	RH		
	6L5-45947-00-00	7 1/4	8 1/4	3	BS	RH		
4A / 5C (--1991)	644-45941-01-00	7 1/4	5	3	B	RH		
	654-45941-01-00	7 1/4	6 1/2	3	B	RH		
	6E0-45943-09-00	7 1/2	7	3	B	RH		
	654-45943-01-00	7 1/4	7 1/4	3	B	RH		
	6E0-45941-09-00	7 1/2	8	3	B	RH		
F4A / F4B / F5A / F6C 4A / 5C (1992--)	6E0-45947-00-00	7 1/4	8 1/4	3	B	RH		
	6E0-45949-00-00	7 1/4	6 1/2	3	BA	RH		
	6E0-45943-01-00	7 1/2	7	3	BA	RH		
	6E0-45941-01-00	7 1/2	8	3	BA	RH		Spline engagement
	6E0-45952-00-00	7 1/4	8 1/4	3	BA	RH		
	6E0-45954-00-00	7 1/2	9	3	BA	RH		
	655-45949-00-00	7 1/4	5	3	C	RH		
6A / 6B / 8A / 8B / E8D	655-45947-01-00	9	5 3/4	3	C	RH		
	655-45945-00-00	9	6 1/2	3	C	RH		
	647-45943-00-00	9	7	3	C	RH		
	655-45943-00-00	9	7 1/2	3	C	RH		
	647-45947-00-00	9	9	3	C	RH		
F6A / F8C / F9,9F / F9,9J 6C / 8C	647-45941-00-00	9 1/4	9 1/4	3	C	RH		
	6G1-45947-00-00	8 1/2	6 1/2	3	N	RH		
	6G1-45943-00-00	8 1/2	7 1/2	3	N	RH		
	6G1-45952-00-00	8 1/2	8	3	N	RH		
	6G1-45941-00-00	8 1/2	8 1/2	3	N	RH		
F8B / F9,9B / F9,9C / F15A / F15C 9,9D / 15D / 9,9F / 15F	6G1-45954-00-00	8 1/2	9 1/4	3	N	RH		
	683-45949-00-00	9 1/2	6 1/2	3	J	RH		
	63V-45947-00-00	9 1/4	8	3	J	RH		
	683-45952-00-00	9 1/4	9 3/4	3	J	RH		
	683-45943-00-00	9 1/4	10 1/2	3	J	RH		
F8B / F9,9B / F9,9C / F15A / F15C / F20B / 9,9D / 15D / 9,9F / 15F	683-45941-00-00	9 1/4	12	3	J	RH		
	63V-45945-10-00	9 1/4	9	3	J1	RH		
	63V-45952-10-00	9 1/4	10	3	J1	RH		
	63V-45943-10-00	9 1/4	11	3	J1	RH		
	63V-45941-10-00	9 1/4	12	3	J1	RH		
F25A / F25D 20C / 20D / 25B / 25D / 25N / 25V / 30A / 30D / 30G	664-45943-01-00	9 7/8	8	3	F	RH		
	664-45941-01-00	9 7/8	9	3	F	RH		
	62C-45941-00-00	9 7/8	10	3	F	RH		
	664-45945-00-00	9 7/8	10 1/2	3	F	RH		
	664-45947-01-00	9 7/8	11 1/4	3	F	RH		
	664-45954-01-00	9 7/8	12	3	F	RH		
	664-45949-02-00	9 7/8	13	3	F	RH		
	664-45952-00-00	9 7/8	14	3	F	RH		
	63D-45941-00-00	12 1/4	8	3	G	RH		
	663-45956-01-00	12 1/4	9	3	G	RH		
F30A / F30B / F40A / F40B / F40F / F50A / F50F / F50H / F60A / F60C / F60F 40H / 40V / 40Q / 40X / 50D / 50G / 50H / PRO 50 / 55B	663-45954-01-00	11 3/4	10	3	G	RH		G-series all-rounder
	663-45958-01-00	11 1/4	14	3	G	RH		
	663-45949-01-00	10 3/4	16	3	G	RH		
	69W-45947-00-00	11 5/8	11	3	G	RH		
	69W-45952-00-00	11 3/8	12	3	G	RH		
G-series commercial Et durable propeller	69W-45945-00-00	11 1/8	13	3	G	RH		
	69W-45958-00-00	11 1/4	14	3	G	RH		
	69W-45943-00-00	11	15	3	G	RH		
	69W-45A47-00-00	11 5/8	11	3	G	RH		G-series commercial Et durable propeller (Alumite treatment for additional durability)
	6H5-45952-00-00	10 5/8	12	3	G	RH		
G-series for light boat	6H5-45945-00-00	10 3/8	13	3	G	RH		
	6H5-45958-00-00	10 1/4	14	3	G	RH		
	6H5-45943-00-00	10	15	3	G	RH		

ALUMINUM SERIES

F70A / F80A / F80B / F100A / F100D / F115A / F115B 60F / 70B / 75A / 75C / PRO75 / 80A / 85A / 90A / 100A / PRO V 100 / 115A / 115B / 115C / 130A / 130B / 140A / 140B / 140C	6E5-45954-00-00	14	11	3	K	RH		
	6E5-45949-00-00	13 5/8	13	3	K	RH		
	6E5-45958-00-00	13 5/8	14	3	K	RH		
	6E5-45947-00-00	13 1/2	15	3	K	RH		
	6E5-45945-01-00	13 1/4	17	3	K	RH		
	6E5-45941-00-00	13	19	3	K	RH		
	6E5-45943-00-00	12 5/8	21	3	K	RH		
	6E5-45952-00-00	13	23	3	K	RH		
	6E5-45956-00-00	13	25	3	K	RH		
	6G5-45941-00-00	15 1/4	15	3	M	RH		
F150A / F175A / F200A / F200C / F200F / F200G 150A / 150C / 150F / Z150P / 175A / 175B / 175D / Z175G / 200A / 200B / 200F / Z200N	6G5-45952-00-00	14 5/8	16	3	M	RH		
	6G5-45947-01-00	14 1/2	17	3	M	RH		
	6G5-45945-01-00	14	19	3	M	RH		
	6G5-45943-01-00	13 3/4	21	3	M	RH		
	6G5-45949-00-00	13 1/2	23	3	M	RH		
FL150A / FL200C / FL200F / FL200G / L150A / L150C / L150F / LZ150P / L200A / L200B / L200F / LZ200N	6K1-45947-00-00	14 1/2	17	3	ML	LH		
	6K1-45945-00-00	14	19	3	ML	LH		

DUAL THRUST SERIES (ALUMINUM)

Outboard Model	Part Number	Diameter	Pitch	Blade	Hub	Rotation	Price	Remark
6C / 8C	6G1-W4592-00-00	9	5	3	N	RH		
F6A / F8C / F9,9F / F9,9J	6G1-W4591-01-00	9	7	3	N	RH		
F8B / F9,9B / F9,9C / F15A / F15C	683-W4592-02-00	9 3/4	6 1/2	3	J	RH		
9,9D / 15D / 9,9F / 15F	683-W4591-02-00	9 3/4	8	3	J	RH		
FT8D / F9,9A / FT9,9D / FT9,9G / FT9,9L	69G-45941-00-00	11 3/4	5 3/4	3	R	RH		
	69G-45943-00-00	11 3/4	7	3	R	RH		
	6G8-45947-00-00	11 3/4	9 1/4	3	R	RH		
FT25B / FT25F	68U-45941-00-00	12 1/4	9	3	G	RH		
FT50B / FT50C / FT50G / FT50J / FT60B / FT60D / FT60G	68S-45941-00-00	14	11	3	K	RH		

TALON SERIES (ALUMINUM)

Outboard Model	Part Number	Diameter	Pitch	Blade	Hub	Rotation	Price	Remark
60F / 70B / 75A / 75C / PRO75 / 80A / 85A / 90A / 100A / PRO V	6EK-45941-00-00	13 1/2	9	3	K	RH		
100 / 115A / 115B / 115C / 130A / 130B / 140A / 140B / 140C	6EK-45943-00-00	13 1/2	10 1/2	3	K	RH		
	6EK-45945-00-00	13 1/2	12	3	K	RH		
	6EK-45947-00-00	13 1/2	14	3	K	RH		
F70A / F80A / F80B / F100A / F100D / F115A / F115B	6EK-45949-00-00	13 1/2	16	3	K	RH		

BLACK STAINLESS STEEL SERIES

Outboard Model	Part Number	Diameter	Pitch	Blade	Hub	Rotation	Price	Remark	
F25A / F25D	664-45972-00-00	9 1/8	12	3	F	RH			
20C / 20D / 25D / 25N / 25B / 25V / 30A / 30D / 30G	664-45970-00-00	9 1/8	13	3	F	RH			
	663-45972-60-00	12	11	3	G	RH			
F30A / F30B / F40A / F40B / F40F / F50A / F50F / F50H / F60A / F60C / F60F 40H / 40V / 40Q / 40X / 50D / 50H / 50G / PRO50 / 55B	663-45970-60-00	11 3/4	12	3	G	RH			
	663-45974-02-00	10 5/8	13	3	G	RH			
	663-45974-60-00	11 1/2	13	3	G	RH			
	663-45930-00-98	10 1/4	14	3	G	RH			
	663-45976-00-00	10 1/4	15	3	G	RH			
	663-45978-00-98	10 1/4	16	3	G	RH			
F70A / F80A / F80B / F100A / F100D / F115A / F115B 60F / 70B / 75A / 75C / PRO75 / 80A / 85A / 90A / 100A / PROV100 / 115A / 115B / 115C / 130A / 130B / 140A / 140B / 140C	688-45932-60-00	13 1/2	14	3	K	RH			
	688-45978-60-00	13 1/2	16	3	K	RH			
	688-45930-02-00	13	17	3	K	RH			
	688-45970-03-00	13	19	3	K	RH			
	688-45972-02-00	13	21	3	K	RH			
	688-45974-02-00	13	23	3	K	RH			
	688-45976-01-98	13	25	3	K	RH			
	6L6-45930-01-00	13	17	3	KL	LH			
	FL115A / FL115B	6L6-45970-00-00	13	19	3	KL	LH		
	L130A / L130B / L140B / L140C	6L6-45972-00-00	13	21	3	KL	LH		

BLACK STAINLESS STEEL SERIES

F150A / F200A / F200C / F225A / F225B / F250A / F250B	6G5-45932-00-00	15 3/4	13	3	M	RH		
150A / 150C / 150F / Z150P / 175A / 175B / 175D / Z175G	6G5-45978-03-00	13 3/4	17	3	M	RH		
/ 200A / 200B / 200F / Z200N / 220A / 225A / 225B / 225D / 250A / 250B / 250G / Z250D	6G5-45972-02-00	13 3/4	21	3	M	RH		
FL150A / FL200A / FL200C / FL225A / FL225B / FL250A / FL250B	6G5-45976-01-00	13 3/8	23	3	M	RH		
L150A / L150C / L150F / LZ150P / L200A / L200B / L200F / LZ200N / L250A / L250B / L250G / LZ250D	6G5-45930-00-00	13 3/8	25	3	M	RH		
	6K1-45970-01-00	15 1/4	15	3	ML	LH		
	6K1-45978-02-00	13 3/4	17	3	ML	LH		
	6K1-45974-02-00	13 3/4	19	3	ML	LH		
	6K1-45972-01-00	13 3/4	21	3	ML	LH		
	6K1-45976-00-00	13 3/8	23	3	ML	LH		

PERFORMANCE SERIES 3 BLADES

Outboard Model	Part Number	Diameter	Pitch	Blade	Hub	Rotation	Price	Remark
F30A / F30B / F40A / F40B / F40F / F50A / F50F / F50H / F60A / F60C / F60F	MAR-GYT3B-03-13	10 1/2	13	3	G	RH		
40H / 40V / 40Q / 40X / 50D / 50H / 50G / PRO50 / 55B	MAR-GYT3B-03-15	10 1/2	15	3	G	RH		
F70A / F80A / F80B / F100A / F100D / F115A / F115B	MAR-GYT3B-V4-18	13 1/4	18	3	K	RH		
60F / 70B / 75A / 75C / PRO75 / 80A / 85A / 90A / 100A / PROV100 / 115A / 115B / 115C / 130A / 130B / 140A / 140B / 140C	MAR-GYT3B-V4-20	13 1/4	20	3	K	RH		
	MAR-GYT3B-V4-22	13 1/4	22	3	K	RH		
FL115A / FL115B	MAR-GYT3B-L4-18	13 1/4	18	3	KL	LH		
L130A / L130B / L140B / L140C	MAR-GYT3B-L4-20	13 1/4	20	3	KL	LH		
	MAR-GYT3B-L4-22	13 1/4	22	3	KL	LH		
F150A / F200A / F200C / F225A / F225B / F250A / F250B	MAR-GYT3B-V6-16	14 1/4	16	3	M	RH		
150A / 150C / 150F / Z150P / 175A / 175B / 175D / Z175G	MAR-GYT3B-V6-18	14 1/4	18	3	M	RH		
200A / 200B / 200F / Z200N / 220A / 225A / 225B / 225D / 250A / 250B / 250G / Z250D / Z300A	MAR-GYT3B-V6-20	14 1/4	20	3	M	RH		
	MAR-GYT3B-V6-22	14 1/4	22	3	M	RH		
	MAR-GYT3B-V6-24	14 1/4	24	3	M	RH		
	MAR-GYT3B-V6-26	14 1/4	26	3	M	RH		
FL150A / FL200A / FL200C / FL225A / FL225B / FL250A / FL250B	MAR-GYT3B-L6-18	14 1/4	18	3	ML	LH		
L150A / L150C / L150F / LZ150P / L200A / L200B / L200F / LZ200N / L250A / L250B / L250G / LZ250D / LZ300A	MAR-GYT3B-L6-20	14 1/4	20	3	ML	LH		
	MAR-GYT3B-L6-22	14 1/4	22	3	ML	LH		

PERFORMANCE SERIES 4 BLADES

Outboard Model	Part Number	Diameter	Pitch	Blade	Hub	Rotation	Price	Remark
F70A / F80A / F80B / F100A / F100D / F115A / F115B	MAR-GYT4B-V4-18	13 1/4	18	4	K	RH		
60F / 70B / 75A / 75C / PRO75 / 80A / 85A / 90A / 100A / PROV100 / 115A / 115B / 115C / 130A / 130B / 140A / 140B / 140C	MAR-GYT4B-V4-20	13 1/4	20	4	K	RH		
	MAR-GYT4B-V4-22	13 1/4	22	4	K	RH		May require replacement of trim tab with 6E5-45371-10-00
	MAR-GYT4B-V4-23	13 1/4	23	4	K	RH		
F150A / F200A / F200C / F225A / F225B / F250A / F250B	MAR-GYT4B-V6-18	13 3/4	18	4	M	RH		
150A / 150C / 150F / Z150P / Z150Q (VMAX) / 175A / 175B / 175D / Z175G / 200A / 200B / 200F / 200G / PROV200 / Z200N / Z200P (HPDI) / 220A / 225A / 225B / 225D / 225G (VMAX) / 250A / 250B / 250G / Z250D / Z250F (VMAX) / Z300A	MAR-GYT4B-V6-20	13 3/4	20	4	M	RH		
	MAR-GYT4B-V6-22	13 3/4	22	4	M	RH		
	MAR-GYT4B-V6-24	13 3/4	24	4	M	RH		
	MAR-GYT4B-V6-26	13 3/4	26	4	M	RH		

K SERIES TALON STAINLESS STEEL (WITH SDS)

Outboard Model	Part Number	Diameter	Pitch	Blade	Hub	Rotation	Price	Remark
	6N7-45970-00-00	13 1/8	14	3	K	RH		
	6N7-45972-00-00	13 1/8	16	3	K	RH		
F70A / F80B / F100D / F115A/B / F130A	6N7-45974-00-00	13 1/8	18	3	K	RH		
	6N7-45976-00-00	13 1/8	19	3	K	RH		NEW FOR 2016
	6N7-45978-00-00	13 1/8	20	3	K	RH		
	6N7-45930-00-00	13 1/8	22	3	K	RH		NEW FOR 2016
	6N7-45932-00-00	13 1/8	24	3	K	RH		NEW FOR 2016
FL115A/B	6N4-45970-00-00	13 1/8	14	3	K	LH		NEW FOR 2016
	6N4-45972-00-00	13 1/8	16	3	K	LH		NEW FOR 2016
	6N4-45974-00-00	13 1/8	18	3	K	LH		NEW FOR 2016
	6N4-45978-00-00	13 1/8	20	3	K	LH		NEW FOR 2016

PRO SERIES

Outboard Model	Part Number	Diameter	Pitch	Blade	Hub	Rotation	Price	Remark
F70A / F80A / F80B / F100A / F100D / F115A / F115B	62A-45976-00-00	13 1/2	17	3	K	RH		
60F / 70B / 75A / 75C / PRO75 / 80A / 85A / 90A / 100A / PROV100 / 115A / 115B / 115C / 130A / 130B / 140A / 140B / 140C	62A-45974-10-00	13 1/2	19	3	K	RH		
	62A-45970-10-00	13 1/2	21	3	K	RH		
	62A-45972-10-00	13 1/2	23	3	K	RH		
VMAX 200 HPDI (Z200P)	6J9-45976-10-00	14 1/2	21	3	M	RH		
	66K-45974-B0-00	14 1/2	23	3	M	RH		
	66K-45972-B0-00	14 1/2	25	3	M	RH		
	66K-45970-B0-00	14 1/4	27	3	M	RH		

RELIANCE SERIES (NON-SDS)

Outboard Model	Part Number	Diameter	Pitch	Blade	Hub	Rotation	Price	Remark
F150A / F200A / F200C / F225A / F225B / F250A / F250B	68F-45970-00-00	14 1/2	15	3	M	RH		Not recommended for the F150A.
150A / 150C / 150F / Z150P / 175A / 175B / 175D / Z175G	68F-45972-00-00	14 1/4	17	3	M	RH		
200A / 200B / 200F / Z200N / 220A / 225A / 225B / 225D / 250A / 250B / 250G / Z250D / Z300A	68F-45978-00-00	14 1/4	18	3	M	RH		
	68F-45974-00-00	13 3/4	19	3	M	RH		
	68F-45976-00-00	13 3/4	21	3	M	RH		
FL150A / FL200A / FL200C / FL225A / FL225B / FL250A / FL250B	68G-45972-00-00	14 1/4	17	3	ML	LH		
L150A / L150C / L150F / LZ150P / L200A / L200B / L200F / LZ200N / L250A / L250B / L250G / LZ250D / LZ300A	68G-45978-00-00	14 1/4	18	3	ML	LH		
	68G-45974-00-00	13 3/4	19	3	ML	LH		
	68G-45976-00-00	13 3/4	21	3	ML	LH		

RELIANCE SERIES - SDS

Outboard Model	Part Number	Diameter	Pitch	Blade	Hub	Rotation	Price	Remark
	68F-45932-10-00*	14 1/2	13	3	M	RH		
	68F-45930-10-00*	14 1/2	14	3	M	RH		
F150A / F175A / F200A / F200C / F200F / F200G / F225A / F225B / F225C / F225F / F250A / F250B / F250D / F300B	68F-45970-10-00	14 1/2	15	3	M	RH		
	68F-45972-10-00	14 1/4	17	3	M	RH		
	68F-45978-10-00	14 1/4	18	3	M	RH		
	68F-45974-10-00	13 3/4	19	3	M	RH		
	68F-45976-10-00	13 3/4	21	3	M	RH		SDS spacer (6CE-45997-00-00) required for 68F/68G SDS propellers.
	68G-45930-10-00*	14 1/2	14	3	ML	LH		
FL150A / FL200A / FL200C / FL200F / FL200G / FL225A / FL225B / FL225F / FL250A / FL250B / FL250D / FL300B	68G-45970-10-00	14 1/2	15	3	ML	LH		
	68G-45972-10-00	14 1/4	17	3	ML	LH		
	68G-45978-10-00	14 1/4	18	3	ML	LH		
	68G-45974-10-00	13 3/4	19	3	ML	LH		
	68G-45976-10-00	13 3/4	21	3	ML	LH		

* New for 2015

SALTWATER SERIES

Outboard Model	Part Number	Diameter	Pitch	Blade	Hub	Rotation	Price	Remark
F150A / F200A / F200C / F225A / F225B / F225C / F250A / F250B	6R4-45976-A0-00	15 1/4	15	3	M	RH		
150A / 150C / 150F / Z150P / Z150Q (VMAX) / 175A / 175B / 175D / Z175G / 200A / 200B / 200F / 200G / PROV200 / Z200N / Z200P (HPDI) / 220A / 225A / 225B / 225D / 225G (VMAX) / 250A / 250B / 250G / Z250D / Z250F (VMAX) / Z300A	6R4-45978-A0-00	15 1/4	17	3	M	RH		
FL150A / FL200A / FL200C / FL225A / FL225B / FL250A / FL250B	6R4-45970-A1-00	15 1/4	19	3	M	RH		
L150A / L150C / L150F / LZ150P / L200A / L200B / L200F / LZ200N / L250A / L250B / L250G / LZ250D / LZ300A	6R4-45972-A0-00	14 7/8	21	3	M	RH		
	6R4-45974-A0-00	14 1/2	23	3	M	RH		
	6R1-45976-A0-00	15 1/4	15	3	ML	LH		
	6R1-45978-A0-00	15 1/4	17	3	ML	LH		
	6R1-45970-A1-00	15 1/4	19	3	ML	LH		
	6R1-45972-A0-00	14 7/8	21	3	ML	LH		
	6R1-45974-A0-00	14 1/2	23	3	ML	LH		

SALTWATER SERIES II (NON-SDS)

Outboard Model	Part Number	Diameter	Pitch	Blade	Hub	Rotation	Price	Remark
F200A / F200C / F225A / F225B / F225C / F250A / F250B / 220A / 225A / 225B / 225D / 250A / 250B / 250G / Z250D / Z300A	6D0-45976-00-00	15 3/4	15	3	T	RH		
FL200A / FL200C / FL225A / FL225B / FL250A / FL250B	6D0-45978-00-00	15 1/2	17	3	T	RH		
L250A / L250B / L250G / LZ250D / LZ300A	6D0-45970-10-00	15 1/4	19	3	T	RH		
	6D0-45972-10-00	15	21	3	T	RH		
	6D1-45976-00-00	15 3/4	15	3	TL	LH		
	6D1-45978-00-00	15 1/2	17	3	TL	LH		
	6D1-45970-10-00	15 1/4	19	3	TL	LH		
	6D1-45972-10-00	15	21	3	TL	LH		

SALTWATER SERIES II - SDS

Outboard Model	Part Number	Diameter	Pitch	Blade	Hub	Rotation	Price	Remark
F200A / F200C / F225A / F225B / F225C / F225F / F250A / F250B / F250D / F300B	6CE-45930-00-00	15 3/4	13	3	T	RH		
	6CE-45976-00-00	15 3/4	15	3	T	RH		
	6CE-45938-00-00	15 1/2	16	3	T	RH		
	6CE-45978-00-00	15 1/2	17	3	T	RH		
	6CE-45934-00-00	15 1/4	18	3	T	RH		
	6CE-45970-10-00	15 1/4	19	3	T	RH		
	6CE-45932-00-00	15	20	3	T	RH		
	6CE-45972-10-00	15	21	3	T	RH		
	6CE-45936-00-00	14 3/4	22	3	T	RH		
	6CE-45974-00-00	14 3/4	23	3	T	RH		SDS spacer (6CE-45997-00-00) required for 6CE/6CF SDS propellers.
	6CF-45930-00-00	15 3/4	13	3	TL	LH		
	6CF-45976-00-00	15 3/4	15	3	TL	LH		
	6CF-45978-00-00	15 1/2	17	3	TL	LH		
	6CF-45934-00-00	15 1/4	18	3	TL	LH		
FL200A / FL200C / FL225A / FL225B / FL225F / FL250A / FL250B / FL250D / FL300B	6CF-45970-10-00	15 1/4	19	3	TL	LH		
	6CF-45932-00-00	15	20	3	TL	LH		
	6CF-45972-10-00	15	21	3	TL	LH		
	6CF-45936-00-00	14 3/4	22	3	TL	LH		
	6CF-45974-00-00	14 3/4	23	3	TL	LH		

SALTWATER SERIES HS4 (NON-SDS)

Outboard Model	Part Number	Diameter	Pitch	Blade	Hub	Rotation	Price	Remark
F200A / F200C / F225A / F225B / F225C / F250A / F250B	6BR-45B70-00-00	15	21	4	T	RH		
250G	6BR-45B72-00-00	15	22	4	T	RH		
	6BR-45B74-00-00	15	23	4	T	RH		
FL200A / FL200C / FL225A / FL225B / FL250A / FL250B	6BS-45B70-00-00	15	21	4	TL	LH		
L250G	6BS-45B72-00-00	15	22	4	TL	LH		
	6BS-45B74-00-00	15	23	4	TL	LH		

SALTWATER SERIES HS4 - SDS

Outboard Model	Part Number	Diameter	Pitch	Blade	Hub	Rotation	Price	Remark
F200A / F200C / F225A / F225B / F225C / F225F / F250A / F250B / F250D / F300B	6CE-45B70-00-00	15	21	4	T	RH		
	6CE-45B72-00-00	15	22	4	T	RH		
	6CE-45B74-00-00	15	23	4	T	RH		SDS spacer (6CE-45997-00-00) required for 6CE/6CF SDS propellers.
FL200A / FL200C / FL225A / FL225B / FL225F / FL250A / FL250B / FL250D / FL300B	6CF-45B70-00-00	15	21	4	TL	LH		
	6CF-45B72-00-00	15	22	4	TL	LH		
	6CF-45B74-00-00	15	23	4	TL	LH		

SALTWATER SERIES XL (NON-SDS)

Outboard Model	Part Number	Diameter	Pitch	Blade	Hub	Rotation	Price	Remark
F300A / F350A (--2010)	6AW-45970-00-00	16 1/4	17	3	X	RH		
	6AW-45972-00-00	16 1/4	19	3	X	RH		
	6AW-45974-00-00	15 1/2	21	3	X	RH		
	6AW-45976-00-00	15 1/4	23	3	X	RH		
	6AW-45978-00-00	15 1/4	25	3	X	RH		
	6AX-45970-00-00	16 1/4	17	3	XL	LH		
FL300A / FL350A (--2010)	6AX-45972-00-00	16 1/4	19	3	XL	LH		
	6AX-45974-00-00	15 1/2	21	3	XL	LH		
	6AX-45976-00-00	15 1/4	23	3	XL	LH		
	6AX-45978-00-00	15 1/4	25	3	XL	LH		

SALTWATER SERIES XL - SDS GENERATION 1

Outboard Model	Part Number	Diameter	Pitch	Blade	Hub	Rotation	Price	Remark
F350A (2011--)	6AW-45970-10-00	16 1/4	15	3	X	RH		
	6AW-45972-10-00	16 1/4	17	3	X	RH		
	6AW-45974-10-00	15 1/2	19	3	X	RH		
	6AW-45976-10-00	15 1/4	21	3	X	RH		SDS spacer (6AW-45997-10-00) required for 6AW/6AW SDS propellers
	6AW-45978-10-00	15 1/4	23	3	X	RH		
	6AX-45970-10-00	16 1/4	15	3	XL	LH		
FL350A (2011--)	6AX-45972-20-00	16 1/4	17	3	XL	LH		
	6AX-45974-10-00	15 1/2	19	3	XL	LH		
	6AX-45976-10-00	15 1/4	21	3	XL	LH		
	6AX-45978-10-00	15 1/4	23	3	XL	LH		

SALTWATER SERIES XL - SDS GENERATION 2

Outboard Model	Part Number	Diameter	Pitch	Blade	Hub	Rotation	Price	Remark
F350A (2011--)	6AW-45970-20-00	16 1/4	15	3	X	RH		
	6AW-45972-20-00	16 1/4	17	3	X	RH		
	6AW-45974-20-00	15 1/2	19	3	X	RH		
	6AW-45976-20-00	15 1/4	21	3	X	RH		
	6AW-45978-20-00	15 1/4	23	3	X	RH		New for 2015 F350A (2015 --) Need Spacer 6AW-45997-00-00
	6AX-45970-20-00	16 1/4	15	3	XL	LH		
FL350A (2011--)	6AX-45972-20-00	16 1/4	17	3	XL	LH		
	6AX-45974-20-00	15 1/2	19	3	XL	LH		
	6AX-45976-20-00	15 1/4	21	3	XL	LH		
	6AX-45978-20-00	15 1/4	23	3	XL	LH		

SALTWATER SERIES XL4 & XL4-HP - SDS GENERATION 1

Outboard Model	Part Number	Diameter	Pitch	Blade	Hub	Rotation	Price	Remark
F350A	6AW-45B70-10-00	16 1/8	15	4	X	RH		
	6AW-45B72-10-00	16 1/8	17	4	X	RH		
	6AW-45B76-10-00	15 3/8	22	4	X	RH		
	6AW-45B74-10-00	15 3/8	24	4	X	RH		SDS spacer (6AW-45997-10-00) required for 6AW/6AW SDS propellers
	6AX-45B70-10-00	16 1/8	15	4	XL	LH		
	6AX-45B72-10-00	16 1/8	17	4	XL	LH		
FL350A	6AX-45B76-10-00	15 3/8	22	4	XL	LH		
	6AX-45B74-10-00	15 3/8	24	4	XL	LH		

SALTWATER SERIES XL4 & XL4-HP - SDS GENERATION 2

Outboard Model	Part Number	Diameter	Pitch	Blade	Hub	Rotation	Price	Remark
F350A	6AW-45B70-20-00	16 1/8	15	4	X	RH		
	6AW-45B72-20-00	16 1/8	17	4	X	RH		
	6AW-45B76-20-00	15 3/8	22	4	X	RH		
	6AW-45B74-20-00	15 3/8	24	4	X	RH		New for 2015 F350A (2015 --) Need Spacer 6AW-45997-00-00
	6AX-45B70-20-00	16 1/8	15	4	XL	LH		
	6AX-45B72-20-00	16 1/8	17	4	XL	LH		
FL350A	6AX-45B76-20-00	15 3/8	22	4	XL	LH		
	6AX-45B74-20-00	15 3/8	24	4	XL	LH		

E-DRIVE PROPELLER								
E-Drive Model	Part Number	Diameter	Pitch	Blade	Hub	Rotation	Price	Remark
M11	MKY-00137-81-21	---	---	plastic	---	RH		
M15	XEA-45941-00-00	---	---	plastic	---	RH		
M12 / M18 ---2009	MKY-00137-81-21	---	---	plastic	---	RH		
M12 / M18 2010---	MKY-00206-11-22	---	---	plastic	---	RH		
M20 / M26 ---2009	MKY-00137-81-22	---	---	plastic	---	RH		
M20 2010---	MKY-00209-11-60	---	---	plastic	---	RH		
M26 2010---	MKY-00137-81-70	---	---	plastic	---	RH		
M32	MKY-00137-81-29	---	---	plastic	---	RH		

«HYDRA-DRIVE» DIESEL STERN DRIVE BLACK STAINLESS STEEL PROPELLER								
Drive Model	Part Number	Diameter	Pitch	Blade	Hub	Rotation	Price	Remark
Single propeller, right-hand rotation	6U3-45971-00-00	18	13	3	WR	RH		
	6U3-45973-00-00	17 1/2	15	3	WR	RH		
	6U3-45975-00-00	17	17	3	WR	RH		
	6U3-45977-00-00	16 3/4	19	3	WR	RH		
Single propeller, counter rotation	6U3-45979-00-00	16 3/8	21	3	WR	RH		
	6U3-45971-10-00	18	13	3	WL	LH		
	6U3-45973-10-00	17 1/2	15	3	WL	LH		
	6U3-45975-10-00	17	17	3	WL	LH		
TRP (Twin Rotation Propellers) Front	6U3-45977-10-00	16 3/4	19	3	WL	LH		
	6U3-45979-10-00	16 3/8	21	3	WL	LH		
	6U4-45942-00-00	15	22	3	(front)	TRP		
	6U4-45946-00-00	15	23	3	(front)	TRP		
TRP (Twin Rotation Propellers) Rear	6U4-45951-00-00	15	24	3	(front)	TRP		
	6U4-45955-00-98	15	26	3	(front)	TRP		
	6U4-45959-00-98	15	28	3	(front)	TRP		
	6U4-45944-00-00	15	22	3	(rear)	TRP		
TRP (Twin Rotation Propellers) Rear	6U4-45948-00-00	15	23	3	(rear)	TRP		
	6U4-45953-00-00	15	24	3	(rear)	TRP		
	6U4-45957-00-98	15	26	3	(rear)	TRP		
	6U4-45961-00-98	15	28	3	(rear)	TRP		

PROPELLER SPARE PARTS							
Type	Outboard Model	Propeller Mark	Front Spacer	Rear Spacer	Washer	Nut	Cotter pin
Regular Model	F2.5A	BS	6EE-G5987-00-00				
	F4B/F5A/F6C	BA	6EE-G5978-00-00		90201-08M54-00	6EE-G5616-00-00	91409-25030-00
	F8C/F8F	N	6N0-G5978-10-00	N/A (Not Required)			
	F9.9J	N	6G1-45987-02-00		90201-10M01-00	90171-10M01-00	91490-30020-00
	F15C/F20B	J	6E7-45987-01-00				
	F25D	F	6L2-45987-01-00	689-45997-00-00	92990-14200-00	90171-14013-00	914-90300-30-00
	F30B/F40F	G	663-45987-02	66T-45997-00-00	90389-22M01-00		
	F50H/F60F	G			90389-22M01	90171-16011-00	914-90300-30-00
	F70A	K	688-45987-01-00	67F-45997-00-00	90389-25M00-00		
	F80B/F100D	K			90389-25M00		
	F(L)115A/F(L)115B/F130A	K, KL					
	F(L)150A/F(L)150D	M, ML	63P-45987-00-00				
Dual Thrust Model	F175A/F(L)200F	M/T, ML/TL		688-45997-01-00	92990-18200-00	90171-18M04-00	91490-40030-00
	F(L)225F/F(L)250D/F(L)300B (4,2L V6)	T, TL	69J-45987-00-00				
	F(L)350A (V8)	X, XL	6AW-45987-00-00	6AW-45997-00	90201-19M01-00		
	FT8D/FT8G	R	6G8-45987-02-00	6G8-45997-00 00	90201-10M02-00	90171-10M07-00	
	FT9.9L	R					914-90300-30-00
	FT25F	G	663-45987-02	68U-45997-00-00	92990-16200-00	90171-16011-00	
	FT50J, FT60G	K	688-45987-01-00	67F-45997-00-00	90389-25M00-00		

PROPELLER ACCESSORIES



PROP WRENCH

Specially made to fit the prop nut on a Yamaha V4 or V6 outboard, it also has a helpful 9/16" square opening on the reverse side, designed for opening garboard drain plugs.
MAR-PRPWR-NC-H1

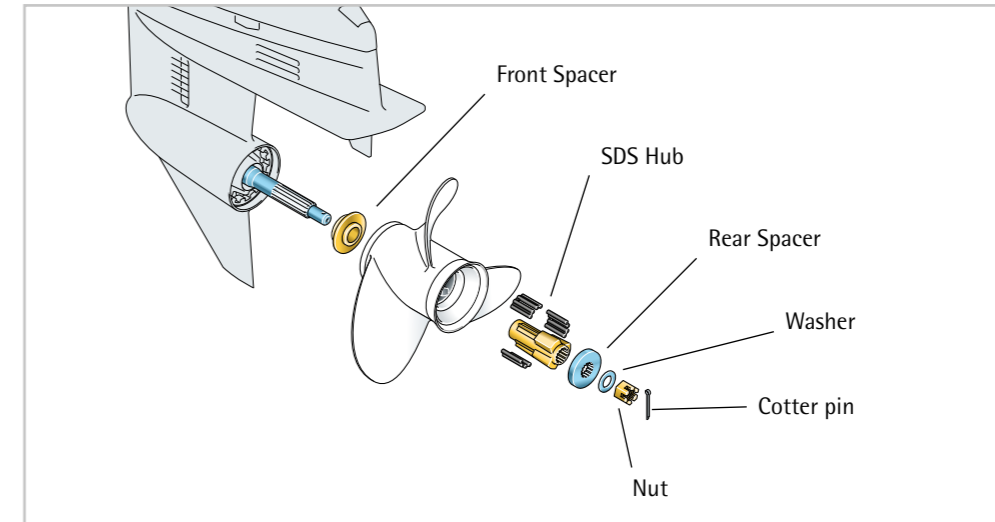

SDS SPACERS

Required for installing an SDS propeller on engines with non-SDS propellers installed - or when the engine in the crate is equipped with a non-SDS spacer.

Part No	Description	QTY	Price
6AW-45997-10-00	For Saltwater XL/XL4 (SDS Gen.1)	1	
6AW-45997-00-00	For Saltwater XL/XL4 (SDS Gen.2 and non-SDS)	1	
6CE-45997-00-00	For F225F/F250D/F300B V6 4.2L, F200F/G, F175A, F150A	1	



SDS HUBS

If the damper hub eventually wears on an SDS prop, a replacement hub is available to restore its original shift-dampening efficiency and performance.

Part No	Description	QTY	Price
6AW-45C80-00-00	For F350A V8 SDS propeller (Gen1 from --2014)	1	
	For F350A V8 SDS propeller (Gen2 from 2015 --)	1	
6CE-45C81-00-00	For F225F/F250D/F300B V6 4.2L, F200F/G, F175A, F150A SDS propeller	1	
6EK-45C82-09-00	For TALON aluminium and Stainless Steal propeller	3	

HELM MASTER™



Fully Integrated Boat Control System

Handling a boat with more than one outboard* has never been as easy as it is now. Because with Helm Master's intuitive joystick, single lever engine control, fully automatic trim system and touch-button speed control, confident boat handling just became your speciality! It really is that simple, because with this fully integrated drive-by-wire system, relaxed and intuitive boat handling comes naturally - even manoeuvring and docking become a real pleasure to look forward to.

* Helm Master is compatible with twin and triple installations of Yamaha 4-stroke V8 (F350A) and 4.2L V6 engines.



NOT JUST A JOYSTICK!

Helm Master integrates all these key functions:
 • Steering • Throttle • Shifting • Trim • Ignition • Engine & boat data • Security

... AND THERE'S MORE

• Easy-to-read HD 5" LCD display • Keyless electronic ignition • Anti-theft system (RFID keyfob) • Speed-sensitive steering friction

Some restrictions apply. Available on selected twin and triple Yamaha outboard installations and only on new boat packages manufactured by participating boat builders and sold by Authorised Dealers.

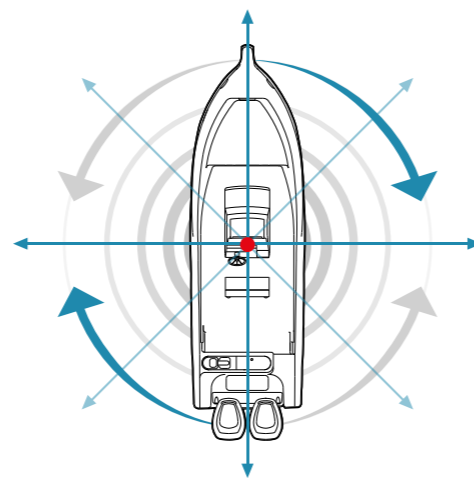

STATION SELECTOR

The touch of a button selects 2nd station operation.

SPEED CONTROL

Once the desired rpm is reached, hold it by pressing the Speed Control - then throttle up or down with the touch of a button.

SINGLE LEVER CONTROL

This button synchronises the control of up to three outboards with a single lever.

TWIN AND TRIPLE SWITCH PANELS

Just one panel controls up to three outboards. Engage all engines with a single key fob and use the 'All Start' button (triple switch panel version only) to start them simultaneously.



MOVING Laterally

Push the joystick to the left or right and your boat will respond effortlessly. This is especially helpful when docking in tight spaces. More force on the joystick will deliver more thrust and directional movement. High and Standard thrust modes allow you to adjust the thrust level quickly - to suit the conditions.



TRIM ASSIST

Press this button and Helm Master automatically adjusts the engine trim to your preferred setting as you accelerate or decelerate.

FREE THROTTLE

Allows the selected engine to be throttled up when the shift function is disengaged.

CENTRE ENGINE

Press the Center Engine button to run only that engine when trolling - or in no-wake zones. (Triple engine installations only)



KEYLESS START

The swipe of a single, keyless fob engages multiple engines - the ultimate in streamlined convenience. Each Helm Master™ system allows for up to four RFID key fobs

360° DIRECTIONAL MOTION AND REAL-TIME RESPONSE

With the central pivot point near the operator and the helm, movement emanates from this location in 360° concentric rings. Place pressure on the joystick in a given direction and the engines respond instantly. A light push or twist of the joystick delivers a slower-paced movement with minimal thrust, while more pressure increases thrust and movement.

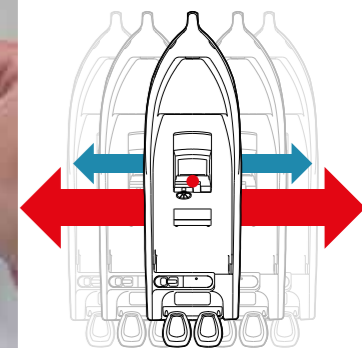

Instruments

Today's boat owners want more information than ever before - and Yamaha Digital Network Gauges deliver it.

Yamaha is proud to offer a comprehensive line-up of Digital Network Gauges, to bring you more convenience, flexibility, and clear information than you ever thought possible. This really is the leading edge of rigging technology, matched up with the supreme level of innovation and reliability you've come to expect from Yamaha. Experience it.



PREMIUM DIGITAL NETWORK GAUGE (6Y9)

Featuring a 5" full-colour, high-resolution LCD display, the 6Y9 Premium Digital Network Gauge II can be configured to display multiple combinations of information based on the operator's preference both for the outboard(s) and the boat status. Available as a convenient Rigging Kit (see page 28)

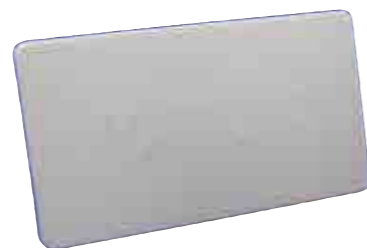

DESCRIPTION	PART NO	PRICE
6Y9 Colour Display	6Y9-83710-13-00	
Replacement Cover	6Y9-87278-00-00	
Replacement Bezel	6Y9-83512-00-00	

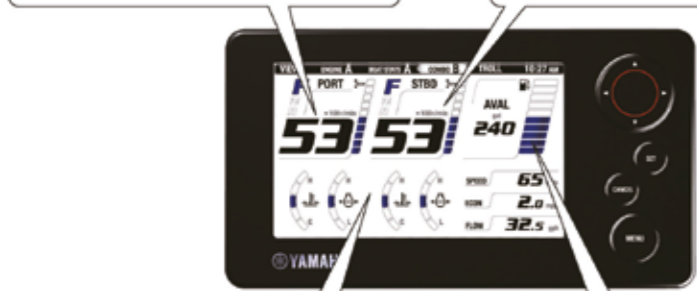
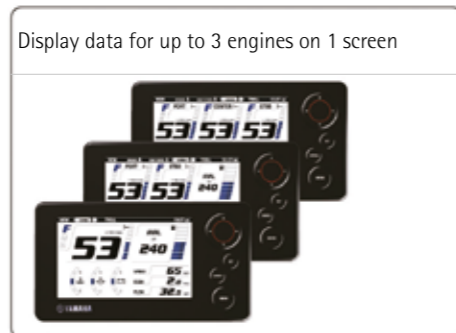

REGULAR INDICATION:

- Shift position
- Engine speed
- Trim position
- Engine temperature
- Cooling water pressure
- Oil pressure
- Main battery voltage
- Sub-battery voltage
- Boat speed
- Fuel economy
- Fuel consumption
- Fuel flow
- Engine operating hours
- Trip meter
- Available fuel volume
- Connections for up to 4 tanks
- Seawater temperature
- Depth
- Maintenance interval notice
- Trolling speed adjustment (depending on model)

ALERT INDICATION:

- Overheat
- Low oil pressure
- Low voltage
- Water in fuel
- Check engine

CONDITION INDICATION:

- Yamaha security system on duty
- Under warming up control
- Under synchronization control

NEW DUAL-PROTOCOL DIGITAL NETWORK GAUGE (6YC)

Full-colour 4.3" TFT display with adjustable illumination, low reflection filter and anti-dazzle Night Mode. Dual protocol (6Y8 and 6Y9) capability with easy-operation buttons to select readouts for multiple functions, including warnings, Y-COP activation and boat system control information. Application: All fuel injection outboard models (F30B and up). Supports single and twin engine applications. (Triple not supported)

INDICATION	UNITS
Engine speed	100 r/min
Trim indication	11 levels (10 segments)
Engine temperature	5 levels
Cooling water pressure	5 levels
Oil pressure	5 levels
Voltage	5 levels or volt
Total operating hour	0-99999 Hr
Trip hour	0.0-999.9 Hr
Immobilizer indicator	Activate/deactivate
Maintenance notification	100 Hrs interval
Illumination control	6 steps
Trolling speed adjustment	50 r/min steps
Boat speed (pitot)*	MPH, km/h or knot
Boat speed (GPS)*	MPH, km/h or knot
2 tank fuel level	11 levels (10 segments)
Fuel flow	GPH, L/h
Fuel Economy	MPG, km/L or nm/L
Fuel consumption	U.S. Gallon or Litter
Depth*	Feet, meter
Sea Temperature*	Fahrenheit or Celsius
Clock*	24 hours
Trip distance*	mile, km or N-mile (0.0-9999)
Diagnosis code	up to 5 codes (each engine)
Alert	Overheat/Low oil press./Water in fuel/ Low voltage/Check engine

* Optional function

DIGITAL NETWORK GAUGES (6Y8 ROUND)

6Y8 Digital Network Gauges are simple, streamlined and sophisticated. The large LCD displays provide easy-to-read information at a glance, allowing you to monitor everything from engine function and fuel management to trim levels, battery voltage, and more. Available as a convenient Rigging Kit (see page 28)

GENERAL FEATURES:

- Each LCD display can show multiple types of information.
- Information is shown in 2 different formats for main (large - on top) and sub-information (small - below).
- Pre-selectable sub-information selection.
- Each LCD display performs a self-function check on start-up.
- Backlighting can be dimmed individually or together (when multiple gauges are installed).

6Y8 TACHOMETER (ROUND)

6Y8-8350T-20-00

- Engine speed • Trim position • Oil pressure
- Cooling water pressure (*2) • Total operating hours • Trip hours • Battery voltage
- Engine temperature • Maintenance interval notice • Overheat alert • Low oil pressure alert • Low battery voltage alert • Water in fuel alert • Check Engine alert • Trolling speed adjustment (depends on outboard model) • Diagnosis code



6Y8 SPEED/FUEL COMBINATION METER (ROUND)

6Y8-83500-20-00

- Boat speed (*1) • Trip meter • Clock • Battery voltage • Fuel tank level (up to 2 tanks) • Fuel flow • Fuel consumption • Fuel economy • Seawater temperature (*2) • Seawater depth (*2)



(*1) GPS connection required (NMEA 0813)

(*2) Optional sensor required (see page 45)

OPTIONAL ROUND DASHBOARD

Description	Part Number	Price
DASHBOARD ROUND (2 HOLES)	YMM09D010000	
GAUGE PLATE RINGS (2 PCS)	YMM09PR10000	



DESCRIPTION	PART NUMBER	PRICE
6YC colour display	6YC-83710-00-00	

ANALOG GAUGES

Premium quality analog instruments made to work in perfect harmony with your Yamaha outboard.

Description	Remarks	Price
1 Seedometer Kit/Speedometer assy	Speed. Trip. Time. Fuel. Battery voltage.	
2 Tachometer kit/Tachometer assy	Engine RPM. Trim angle. Oil level. Hour meter. Water separator warning indicator. Warning lamps. Engine warning indicator. Overheat warning lamp.	
3 Water pressure meter kit	Fuel consumption. Fuel economy. Fuel contamination.	
4 Water temp. meter kit		
5 Fuel meter assy		
6 Fuel meter assy		
7 Voltmeter assy		
8 Trim Gauge		
9 Digital speedometer assy		
10 Digital tachometer assy		
11 Digital fuel meter kit Single		
12/22 Speedometer assy		
13/23 Tachometer assy		
14/24 Water pressure meter assy		
15/25 Water temp. assy		
16/26 Hour meter assy		
17/27 Fuel meter assy		
18/28 Trim meter assy		
19/29 Voltmeter assy		



DESCRIPTION	PART NUMBER	COLOUR	DIAM (mm)	6C/D 8C 9,9D/F 15D/F 20C/D	25D/N/V 30A/G	30D	40H 50D	40V 50H	40X 55BE	PRO50 50G	60F 70B	75C PRO75 80A 90A	75A 85	All 2 strokes V4/V6	F6A/B F8C FT8D F9,9C FT9,9A	F20A F25A FT25B	F30A F40A/B/C F45A F50A/F FT-50B/C/G F60A FT60B/D F80A/B F100A/D F150A F115A F30A F225A F250A	REMARKS
1 Speedometer Kit	6Y5W00814000	Black	85	•														Max 80km/h - 43knots - With sender
Speedometer assy	6Y5835103000	Black	85			•	•	•				•	•					• Max 80km/h - 43knots - Without sender
Speedometer Kit	6Y5W00812000	Black	85															• Max 120km/h - 65knots - Without sender
2 Tachometer kit	6Y5W00800200	Black	85					•		•	•	•						With oil lamp - OM until 1993
Tachometer assy	6Y5835400500	Black	85					•		•	•	•						With oil lamp - OM from 1994 and later
Tachometer kit	6Y5W00801200	Black	85	•	•	•												Without lamp - With harness 6Y5835530000
Tachometer assy	6Y5835402000	Black	85															• With oil lamp & water temp. (4stroke)
* Wire Lead	6Y5835530000	Black				•	•	•	•	•	•	•	•	•	•	•	•	• Electric Start engine
3 Water pressure meter kit	6Y5W00880000	Black	52				•	•	•	•	•	•	•	•				• With sender
4 Water temp. meter kit	6Y5W00881000	Black	52				•	•	•	•	•	•	•					• With sender
5 Fuel meter assy	6Y5857501000	Black	52	•	•	•	•	•	•	•	•	•	•	•	•	•	•	• For 33-240 ohm sender
6 Hour meter assy	6Y5835040100	Black	52	•	•	•	•	•	•	•	•	•	•	•	•	•	•	• Mechanical Start engine
7 Voltmeter assy	6Y5835030000	Black	52	•	•	•	•	•	•	•	•	•	•	•	•	•	•	•
8 Trim Gauge	6Y5836700100	Black	52				•	•	•	•	•	•	•	•				• OM until 1991 (short shaft)
Trim Gauge	6Y5836701000	Black	52				•	•	•	•	•	•	•	•				• OM from 1990 to 1993 (long shaft)
Trim Gauge	6Y5836701100	Black	52				•	•	•	•	•	•	•	•				• OM from 1994 to 2000
Trim meter assy	6Y5836701200	Black	52				•	•	•	•	•	•	•	•				• Om from 2001 and later
9 Digital speedometer assy	6Y5835005600	Black	85				•	•	•	•	•	•						• OM from 1994 and later Without pipe
* Tube	6Y5835571000	Black																• Speedo tube. 8m
10 Digital tachometer assy	6Y5835070400	Black	85					•	•	•	•	•						• OM from 1994 and later (trim, Hour meter)
11 Digital fuel meter kit Single	6Y5W00885400	Black	85				•	•	•	•	•	•	•	•	•	•	•	• Single engine (harness ,1 fuel economy sensor)
Digital fuel meter kit Twin	6Y5W00886500	Black	85				•	•	•	•	•	•	•	•	•	•	•	• Twin engines (harness ,2 fuel economy sensor)
* Cord assy 1	6Y5871225000	Black																• Optional
* Wire Lead	6Y585721F000	Black																• Optional
12 Speedometer assy	6Y7835106000	Black	85	•	•	•	•	•	•	•	•	•	•	•	•	•	•	• Max 80km/h - 43knots - Without sender
Speedometer assy	6Y7835104000	Black	85									•	•	•				• Max 120km/h - 65knots - Without sender
13 Tachometer assy	6Y7835400000	Black	85					•		•	•	•						• With oil lamp - OM from 1994 and later
Tachometer assy	6Y7835402000	Black	85	•	•	•												• Without lamp
Tachometer assy	6Y7835404000	Black	85															• With oil lamp, water temp. (4 stroke)
14 Water pressure meter assy	6Y7836600000	Black	52				•	•	•	•	•	•	•	•				• Without sender
* Sender	688836670000	Black																• With 10m tube
15 Water temp. assy	6Y7835900000	Black	52				•	•	•	•	•	•	•	•				• Without sender
* Thermo unit	688835910000	Black																• With 7m harness
16 Hour meter assy	6Y7835040000	Black	52	•	•	•	•	•	•	•	•	•	•	•	•	•	•	• Digital
17 Fuel meter assy	6Y7857501000	Black	52	•	•	•	•	•	•	•	•	•	•	•	•	•	•	• For 33-240 ohm sender
18 Trim meter assy	6Y7836700000	Black	52				•	•	•	•	•	•	•	•				• Om from 2001 and later
19 Voltmeter assy	6Y7835030000	Black	52	•	•	•	•	•	•	•	•	•	•	•	•	•	•	•
20 Hour meter	ENGMETER4C0100	Black																• 2 stroke - 4 stroke
21 Hour & Tacho meter	ENGMETER4C0200	Black																• 4 stroke
22 Speedometer assy	6Y7835107000	White	85	•	•	•	•	•	•	•	•	•	•	•	•	•	•	• Max 80km/h - 43knots - Without sender
Speedometer assy	6Y7835105000	White	85															• Max 120km/h - 65knots - Without sender
23 Tachometer assy	6Y7835401000	White	85					•		•	•	•						• With oil lamp - OM from 1994 and later
Tachometer assy	6Y7835403000	White	85	•	•	•												• Without lamp
Tachometer assy	6Y7835405000	White	85															• With oil lamp & water temp. (4stroke)
24 Water pressure meter assy	6Y7836602000	White	52				•	•	•	•	•	•	•	•				• Without sender
* Sender	688836670000	White																• With 10m tube
25 Water temperature assy	6Y7835901000	White	52				•	•	•	•	•	•	•	•				• Without sender
* Themo unit	688835910000	White																• With 7m harness
26 Hour meter assy	6Y7835041000	White	52															• Digital
27 Fuel meter assy	6Y7857503000	White	52	•	•	•	•	•	•	•	•	•	•	•	•	•	•	• For 33-240 ohm sender
28 Trim meter assy	6Y7836702000	White	52				•	•	•	•	•	•	•	•				• Om from 2001 and later
29 Voltmeter assy	6Y7835031000	White	52	•	•	•	•	•	•	•	•	•	•	•	•	•	•	•

It is possible to install these analog instruments on all V6 - 4.2l F(L)225F/F(L)250D/F(L)300B and V8 F(L)350A (from 2011 onwards) with AGI interface: 6Y98A2D03000 (page 47)

Remote Controls



Yamaha Remote Controls set the standard for operator comfort, convenience and flexibility. Their intuitive ergonomic designs allow for virtually effortless, one-hand control of throttle and shift functions, and allow for surprisingly easy command of horsepower and multiple engine installations.

REMOTE CONTROL TYPE	MODEL	MOUNTING POSITION	NUMBER OF ENGINES		
			Single	Twin	Triple
DIGITAL (DRIVE-BY-WIRE) (F200G - F350A)	6X6	Top Mount	X	X	X
	6X7	Flush Mount	X		
MECHANICAL (F30 - F200F)	703	Side Mount	X		
	704	Top Mount	X	X	
	6X3	Flush Mount	X		

Side Mount

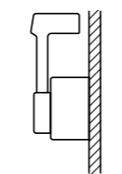

Top Mount

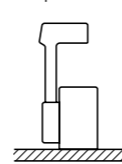

Flush Mount

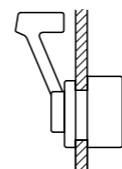

DIGITAL DRIVE-BY-WIRE (DBW) REMOTE CONTROLS

The operation of throttle and shift is controlled electronically by the Digital Network System, providing you with smoother remote control - and with no cable friction! Multiple engine remote controls feature automatic engine RPM synchronization. Thanks to the convenience of our "plug and play" systems, rigging work is now simplicity itself - even 2nd station installation is a breeze.

DBW REMOTE CONTROL BOX FOR SINGLE STATION

#	Part Number	Variation Code	Engine	Mount	Price	Dual Station		Remarks
						Single Station	Dual Station	
1	6X6-48205-36-00	A	Single			1		Single station only
2	6X6-48207-36-00	B	Twin	Top mount		1		(no extension for dual-station)
3	6X6-48208-45-00	F	Triple			1	1	
4	6X7-48206-10-00	A	Single	Flush mount		1		With emergency shut-off cord.

For quad engine installation contact your dealer.

6X6 DIGITAL DBW REMOTE CONTROL

An exclusive suite of binnacle style drive-by-wire remote control boxes. Available in single, twin or triple engine versions and fully compatible with Yamaha's Digital Network Systems.

1 - 6X6 SINGLE ENGINE TOP MOUNT

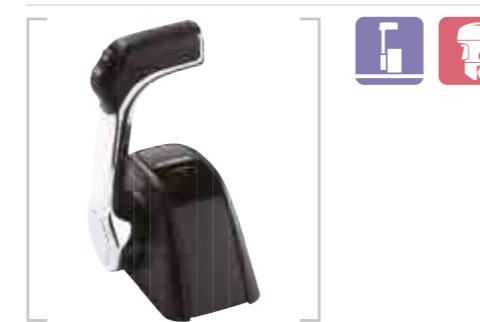

2 - 6X6 TWIN ENGINE TOP MOUNT

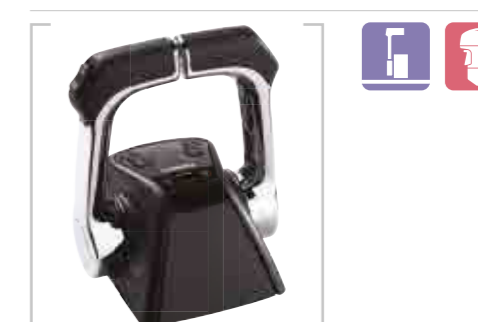

3 - 6X6 TRIPLE ENGINE TOP MOUNT

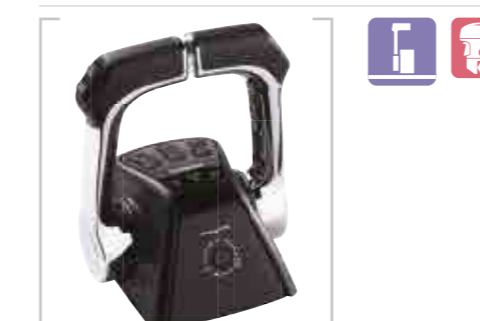

	6Y8 (Round) / 6YC / 6Y9
GAUGE	
ENGINE	
SWITCH	



6X6 CONTROL SPACER KITS

Description	Part Number	Price
6X6 Single Control Box Spacer	MARSHIM86500	
6X6 Twin Control Box Spacer	MARSHIM86600	

6X7 DIGITAL DBW REMOTE CONTROL

A compact, flush side-mounted digital drive-by-wire remote control box with an integrated lanyard switch. Key switch panel and main wire harness supplied separately.

4 - 6X7 SINGLE ENGINE FLUSH MOUNT

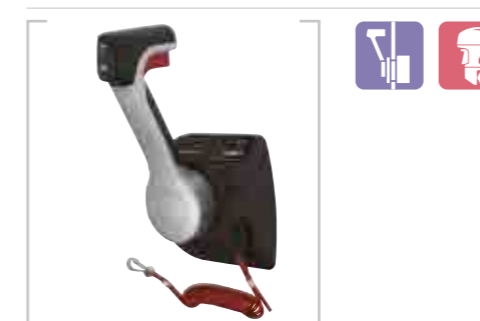

	6Y8 (Round) / 6YC / 6Y9
GAUGE	
ENGINE	
SWITCH	

DBW REMOTE CONTROL BOX FOR DUAL STATIONS

#	Part Number	Variation Code	Engine	Mount	Price	Dual Station		Remarks
						Single Station	Dual Station	
1	6X6-48205-44-00	C	Single			1	1	For main station
	6X6-48205-55-00	G					1	For 2nd station
2	6X6-48207-45-00	D	Twin	Top mount		1	1	For main station
	6X6-48207-54-00	H					1	For 2nd station
3	6X6-48208-45-00	F	Triple			1	1	For main station
	6X6-48208-53-00	K					1	For 2nd station

MECHANICAL REMOTE CONTROLS

Operated by mechanical cable to control throttle and shift mechanism.

703 SINGLE ENGINE SIDE MOUNT

Designed with broad compatibility in mind, this remote control can be fitted to almost every boat type and is compatible with almost every engine in the Yamaha Outboard range. The 703 delivers all of the basic control functions and open throttle can also be configured in either the push or pull direction.

1 - 703 SIDE MOUNT



GAUGE	6Y8 (Round) / 6YC
ENGINE	
SWITCH	-

6X3 SINGLE ENGINE FLUSH MOUNT

A right-side flush mounted mechanical remote control with integrated lanyard switch. Push action to open throttle. Single key switch panel (without lanyard switch) and 10-pin wire harness supplied separately.

2 - 6X3 FLUSH MOUNT



GAUGE	6Y8 (Round) / 6YC
ENGINE	
SWITCH	

704 TOP MOUNT

Designed for use with electric start models and ideally fitted to center console boats. Available in single and twin lever configurations for single and twin engine installations. A switch panel and extension wire harness are required to connect to the engine 10-pin harness.

3 - 704 TOP MOUNT SINGLE



GAUGE	6Y8 (Round) / 6YC
ENGINE	
SWITCH	

4 - 704 TOP MOUNT TWIN



MECHANICAL REMOTE CONTROL BOXES

#	Part Number	Engine	Throttle		PTT	Mount	Price	Remarks
			Push	Pull				
1	703-48207-21-00	Single	1		1	Side mount		For Electric start models.
	703-48260-20-00			1	For Manual start models.			
	703-48206-20-00			1	(replacement of 701 control)			
2	6X3-48206-02-00		1		1	Flush mount		With emergency shut-off cord.
3	704-48205-P1-00		1		1	Top Mount		
4	704-48207-P1-00	Twin	1		1			

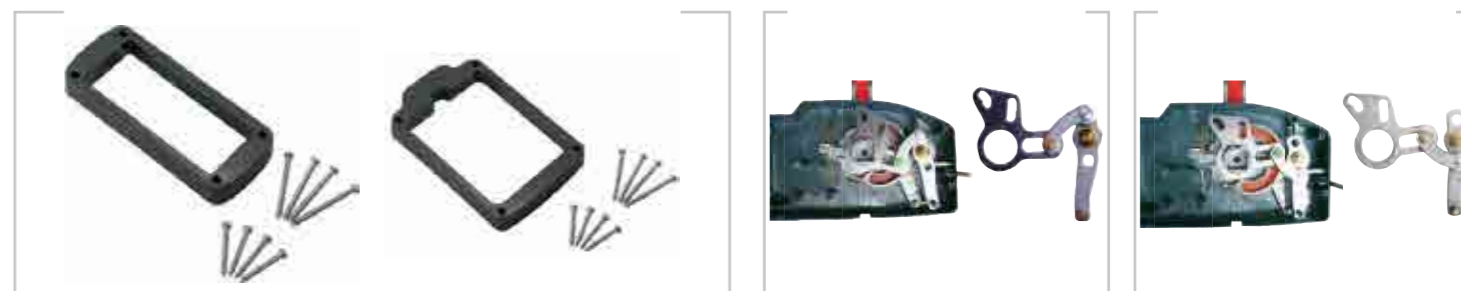

704 CONTROL SPACER KITS

Description	Part Number	Price
For 704 Premium Single	704-48293-20-00	
For 704 Premium Twin	704-48293-30-00	

703 THROTTLE CONVERSION

Description	Part Number	Price
703 Conversion Kit (Pull to Push)	703-48261-01-00	
703 Conversion Kit (Push to Pull)	703-48261-11-00	



REMOTE CONTROL - REMOTE CONTROL ATTACHMENT KITS

The best way to convert your Yamaha outboard throttle and shift cable from manual to remote operation with the least amount of fuss.

- Solid & durable corrosion-resistant construction
- For use with remote controls and control cables
- Steering hook not included

We strongly recommend that all cable specification and installation work be carried out by an Authorised Yamaha Dealer, where further product details and helpful advice are always available.



ENGINE	PART NUMBER	PRICE
9.5A/12A/15A	YMM-21201-00-00	
4A/5C	YMM-21202-00-00	
6B/8B	655-48501-02-00	
6C/D/8C	YMM-21204-00-00	
F6A/F6B/F8C/FT8D	6DR-48501-00-00	
9.9D/15D	YMM-21205-00-00	
9.9F/15F	YMM-21206-00-00	
F15C/F20B	6AH-48501-00-00	
F8A/B/F9.9A/B/FT9.9A	6G8-48501-03-00	
F9.9C/FT9.9D/F15A	66M-48501-00-00	
F9.9F/F9.9J	6DR-48501-00-00	
FT9.9G/FT9.9L	6DR-48501-00-00	

ENGINE	PART NUMBER	PRICE
F25A/F20A/ FT25B	65W-48501-00-00	
F25D	6BL-48501-00-00	
20C/D/V/30A/G/25D	YMM-21207-00-00	
20D/25N ('89)	6L2-48501-10-00	
20D/25N ('90--)	6L2-48501-11-00	
30D (--'93)	6J8-48501-02-EJ	
25J/30D ('94--)	6J8-48501-03-4D	
40Q	6R6-48501-00-00	
40X	66T-48501-01-00	

CONNECTORS FOR ATTACHMENT KITS

Connector to motor	YMM-21220-00-00
Gas connector for YMM-21203-00 and YMM-21205-00	YMM-21230-00-00
Gas connector for YMM-21201-00, YMM-21202-00, YMM-21204-00, YMM-21206-00 and YMM-21207-00	YMM-21232-00-00
Shift connector for YMM-21205-00	YMM-21231-00-00
Shift connector for YMM-21201-00, YMM-21202-00, YMM-21203-00, YMM-21204-00, YMM-21206-00 and YMM-21207-00	YMM-21233-00-00

ULTRAFLEX AND TELEFLEX CONTROLS

Model	Description	Part Number	Price
Ultraflex B183	Flush Side Mount	YMM-21110-00-00	
Ultraflex B85	Flush Side Mount	YMM-21111-00-00	
Ultraflex B89	Side Mount White (6C-50H)	YMM-21100-00-00	
Ultraflex B90	Side Mount Black (6C-50H)	YMM-21100-10-00	
Teleflex Side Mount	(6C-50H)	YMD-RCBOX-00-10	



Ultraflex B183 Ultraflex B85 Ultraflex B89 Ultraflex B90 Teleflex Side Mount

REMOTE CONTROL CABLES

Only the very best cable performs smoothly and reliably enough to be a match for the renowned quality of a Yamaha Remote Control.

Premium PowerMatched control cable (YPM)



- Stainless Steel Rod
- Wiper seal
- 16" max swivel
- Nickel-plated brass sleeve
- Swivel seat
- Rotary swaged stainless steel hub
- Ultraviolet-stabilised high-density polyethylene outer jacket
- Long-lay oil-tempered wires
- High-density polyethylene liner
- Nylon-covered stranded core wire



Splines reduce contact area with liner for ultra low friction

STANDARD CABLE (Y32)

Yamaha offers you a choice of remote control cables that are a perfect match for our controls. These well proven original cables have set the standard with advanced technology that reduces friction and delivers excellent performance. The standard-core wires increase strength and reduce binding, allowing for a 4-inch bend radius.

MID-RANGE CABLE (C8)

This mid-range cable offers great efficiency, thanks to high level of flexibility for a reduced cable bend radius. Featuring stainless steel cables and fittings as well as a very high resistance blue outer jacket for protection against abrasion, UV and chemicals.

PREMIUM POWERMATCHED CONTROL CABLE (YPM)

These are top-of-the-line cables, with features and performance that have made them the first choice of professional riggers. The ultra-low-friction inner core wire has splines and a special cover to reduce contact with the liner, allowing rigging to even tighter tolerances; another benefit is reduced 'play' at the cable ends. We strongly recommend the use of Premium PowerMatched cables for boats with severe applications and long cable lengths, on twin-engine installations - and in fact, on any boat where unrivalled smoothness is required. These cables are designed to run smoothly even if installation demands that curves or a radius be applied within the cable run.

FEET	CM	STANDARD (Y32)	PRICE	MID-RANGE (C8)	PRICE	PREMIUM (YPM)	PRICE
5'	152	YMM-21005-00-00		-		-	
6'	183	YMM-21006-00-00		YMM-21006-C8-00		YMM-21006-PM-30	
7'	213	YMM-21007-00-00		YMM-21007-C8-00		YMM-21007-PM-30	
8'	244	YMM-21008-00-00		YMM-21008-C8-00		YMM-21008-PM-30	
9'	274	YMM-21009-00-00		YMM-21009-C8-00		YMM-21009-PM-30	
10'	305	YMM-21010-00-00		YMM-21010-C8-00		YMM-21010-PM-30	
11'	335	YMM-21011-00-00		YMM-21011-C8-00		YMM-21011-PM-30	
12'	366	YMM-21012-00-00		YMM-21012-C8-00		YMM-21012-PM-30	
13'	396	YMM-21013-00-00		YMM-21013-C8-00		YMM-21013-PM-30	
14'	427	YMM-21014-00-00		YMM-21014-C8-00		YMM-21014-PM-30	
15'	457	YMM-21015-00-00		YMM-21015-C8-00		YMM-21015-PM-30	
16'	488	YMM-21016-00-00		YMM-21016-C8-00		YMM-21016-PM-30	
17'	518	YMM-21017-00-00		YMM-21017-C8-00		YMM-21017-PM-30	
18'	549	YMM-21018-00-00		YMM-21018-C8-00		YMM-21018-PM-30	
19'	579	YMM-21019-00-00		YMM-21019-C8-00		YMM-21019-PM-30	
20'	610	YMM-21020-00-00		YMM-21020-C8-00		YMM-21020-PM-30	
21'	640	YMM-21021-00-00		YMM-21021-C8-00		YMM-21021-PM-30	
22'	671	YMM-21022-00-00		YMM-21022-C8-00		YMM-21022-PM-30	
23'	701	YMM-21023-00-00		YMM-21023-C8-00		YMM-21023-PM-30	
24'	732	YMM-21024-00-00		YMM-21024-C8-00		YMM-21024-PM-30	
25'	762	YMM-21025-00-00		YMM-21025-C8-00		YMM-21025-PM-30	
26'	792	YMM-21026-00-00		YMM-21026-C8-00		YMM-21026-PM-30	
27'	823	YMM-21027-00-00		YMM-21027-C8-00		YMM-21027-PM-30	
28'	853	-		YMM-21028-C8-00		YMM-21028-PM-30	
29'	884	-		YMM-21029-C8-00		YMM-21029-PM-30	
30'	914	YMM-21030-00-00		YMM-21030-C8-00		YMM-21030-PM-30	

Yamaha recommends YPM cables. If not applicable for rigging certain types of boats, C8 or Y32 cables may be used.

SWITCH PANELS - FOR DRIVE-BY-WIRE (DBW)



1 - SINGLE ENGINE KEY SWITCH WITH LANYARD



2 - TWIN/TRIPLE ENGINE KEY SWITCH WITH LANYARD



3 - TWIN ENGINE START/STOP SWITCH



4 - TRIPLE ENGINE START/STOP SWITCH



5 - ALL START/STOP SWITCH



6 - DUAL STATION SELECTOR



7 - DUAL STATION SINGLE ENGINE START/STOP SWITCH



8 - DUAL STATION LANYARD SWITCH

SWITCH PANELS - FOR MECHANICAL REMOTE CONTROL



1 - SINGLE ENGINE KEY SWITCH WITH LANYARD



2 - SINGLE ENGINE MAIN STATION SWITCH WITH PANEL



3 - TWIN ENGINE KEY SWITCH WITH LANYARD



4 - REPLACEMENT LANYARD CORD

#	P/N	Description	Remote control	Remark	Price
1	704-82570-12-00	Single key switch with lanyard	For 704 single	With choke switch	
2	64D-82570-22-00	Single engine Main Station switch with panel	For 6X3/6X7	w/ 2P coupler for Emergency Stop SW	
3	6Y8-82570-04-00	Twin key switch with lanyard	For 704 twin	For Digital network system (6Y8)	
4	682-82556-00-00	Engine shut-off lanyard cord	---	Replacement lanyard cord	

SWITCHES FOR SINGLE STATION

#	Part Number	Description	Engine			Single Station	Dual Station		Price
			Single	Twin	Triple		Main Station	2nd Station	
1	6X6-82570-32-00	Single engine key switch with lanyard	1			1	1		
2	6X6-82570-40-00	Twin engine key switch with lanyard		1		1	1		
2	6X6-82570-50-00	Triple engine key switch with lanyard			1	1	1		
3	6X6-82570-60-00	Twin engine Start/Stop switch - Main Station		1		1	1		
4	6X6-82570-70-00	Triple Engine Start/Stop switch - Main Station			1	1	1		
5	6X6-82570-C0-00	All Start/Stop switch		1	1	1	1		

SWITCHES FOR DUAL STATIONS

#	Part Number	Description	Engine			Single Station	Dual Station		Price
			Single	Twin	Triple		Main Station	2nd Station	
3	6X6-82570-E0-00	Twin engine Start/Stop switch - 2nd Station		1			1		
4	6X6-82570-F0-00	Triple engine Start/Stop switch - 2nd Station			1		1		
6	6X6-82570-B0-00	Station selector - Dual Station	1	1	1	1	1		
7	6X6-82570-80-00	Single engine Start/Stop switch - 2nd Station	1				1		
8	6X6-82570-90-00	Lanyard switch - 2nd Station	1	1	1		1		





Rigging Kits

What exactly do you need for your boat and engine?

Even though Yamaha's Digital Network rigging components are sophisticated, powerful and very advanced, they are made to be simple to understand and to use. We know too, that choosing exactly the right rigging components to fit your boat can still be a hassle ... but don't worry! A Yamaha Rigging Kit will make your choice a breeze - and ordering couldn't be simpler.

RIGGING KITS - FOR DBW REMOTE CONTROL

6Y9 SINGLE RIGGING KIT (WITHOUT SWITCH PANEL) 6Y9-W0035-27-00

Parts Number	Description	Qty
6Y9-83710-13-00	MULTI-FUNCTION COLOUR DISPLAY (6Y9)	1
6Y8-81920-01-00	MULTI-HUB ASSY	1
6Y8-82582-11-00	TERMINAL CAP (4 PIN/DEVICE)	2
6Y8-82553-01-00	MAIN BUS HARNESS 6 PIN (0.3 M / 1 FT)	1
6Y8-82521-31-00	PIGTAIL BUS HARNESS 4 PIN (1.8 M / 6 FT)	1
6Y9-83553-40-00	6Y9 DISPLAY CONVERSION HARNESS	1
6Y9-83553-00-00	DBW MAIN BUS WIRE ADAPTOR HARNESS	1
6Y8-83553-01-00	SYSTEM POWER SUPPLY WIRE (2.4 M / 8 FT)	1
6Y9-8356N-01-00	6Y9 GPS WIRE (NMEA 0183)	1
6Y9-8356N-10-00	6Y9 FUEL WIRE	1
6X6-8258A-30-00	DBW MAIN HARNESS 16 PIN (10 M / 32 FT)	1
6Y9-2819K-E0-00	SET-UP MANUAL	1
6Y9-2819U-72-00	OWNERS MANUAL	1
6Y9-2819U-82-00	OWNERS MANUAL	1

* DBW remote control box and switch panels are required separately.



6Y9 TWIN RIGGING KIT 6Y9-W0035-18-00

Parts Number	Description	Qty
6Y9-83710-13-00	MULTI-FUNCTION COLOUR DISPLAY (6Y9)	1
6Y8-81920-01-00	MULTI-HUB ASSY	1
6Y8-82582-11-00	TERMINAL CAP (4 PIN/DEVICE)	2
6Y8-82553-01-00	MAIN BUS HARNESS 6 PIN (0.3 M / 1 FT)	1
6Y8-82521-31-00	PIGTAIL BUS HARNESS 4 PIN (1.8 M / 6 FT)	1
6Y9-83553-40-00	6Y9 DISPLAY CONVERSION HARNESS	1
6Y9-83553-00-00	DBW MAIN BUS WIRE ADAPTOR HARNESS	1
6Y8-83553-01-00	SYSTEM POWER SUPPLY WIRE (2.4 M / 8 FT)	1
6Y9-8356N-01-00	6Y9 GPS WIRE (NMEA 0183)	1
6Y9-8356N-10-00	6Y9 FUEL WIRE	1
6X6-82570-40-00	TWIN ENGINE MAIN SWITCH PANEL	1
6X6-82570-60-00	TWIN ENGINE START/STOP PANEL	1
6X6-8258A-40-00	DBW MAIN HARNESS 16 PIN (12 M / 38 FT)	2
6Y9-2819K-E0-00	SET-UP MANUAL	1
6Y9-2819U-72-00	OWNERS MANUAL	1
6Y9-2819U-82-00	OWNERS MANUAL	1

* DBW remote control box is required separately.



6Y9 TRIPLE RIGGING KIT 6Y9-W0035-46-00

Parts Number	Description	Qty
6Y9-83710-13-00	MULTI-FUNCTION COLOUR DISPLAY (6Y9)	1
6Y8-81920-01-00	MULTI-HUB ASSY	1
6Y8-82582-11-00	TERMINAL CAP (4 PIN/DEVICE)	2
6Y8-82553-01-00	MAIN BUS HARNESS 6 PIN (0.3 M / 1 FT)	1
6Y8-82521-31-00	PIGTAIL BUS HARNESS 4 PIN (1.8 M / 6 FT)	1
6Y9-83553-40-00	6Y9 DISPLAY CONVERSION HARNESS	1
6Y9-83553-00-00	DBW MAIN BUS WIRE ADAPTOR HARNESS	1
6Y8-83553-01-00	SYSTEM POWER SUPPLY WIRE (2.4 M / 8 FT)	1
6Y9-8356N-01-00	6Y9 GPS WIRE (NMEA 0183)	1
6Y9-8356N-10-00	6Y9 FUEL WIRE	1
6X6-82570-50-00	TRIPLE ENGINE MAIN SWITCH PANEL	1
6X6-82570-70-00	TRIPLE ENGINE START/STOP PANEL	1
6X6-8258A-40-00	DBW MAIN HARNESS 16 PIN (12 M / 38 FT)	3
6Y9-2819K-E0-00	SET-UP MANUAL	1
6Y9-2819U-72-00	OWNERS MANUAL	1
6Y9-2819U-82-00	OWNERS MANUAL	1

* DBW remote control box is required separately.



RIGGING KITS - FOR DBW REMOTE CONTROL

6YC SINGLE RIGGING KIT (WITHOUT SWITCH PANEL)
6Y8-W0035-D2-00

Parts Number	Description	Qty
6YC-83710-00	6YC MULTI FUNCTION COLOUR DISPLAY	1
6Y8-81920-01-00	MULTI-HUB ASSY	1
6Y8-82582-11-00	TERMINAL CAP (4 PIN/DEVICE)	1
6Y8-82521-11-00	PIGTAIL BUS HARNESS 4 PIN (0.6 M / 2 FT)	1
6Y8-82521-31-00	PIGTAIL BUS HARNESS 4 PIN (1.8 M / 6 FT)	1
6Y8-8356N-01-00	6Y8 GPS/FUEL WIRE (NMEA 0183)	1
6Y8-83553-01-00	SYSTEM POWER SUPPLY WIRE (2.4 M / 8 FT)	1
6X6-8258A-30-00	DBW MAIN HARNESS 16 PIN (10 M / 32 FT)	1
6YC-2819U-70-00	OWNER'S MANUAL	1
6YC-2819U-80-00	OWNER'S MANUAL	1

* DBW remote control box and switch panels are required separately.



6Y9 SECOND GAUGE KIT
6Y9-W0035-36-00

Parts Number	Description	Qty
6Y9-83710-13-00	MULTI-FUNCTION COLOUR DISPLAY (6Y9)	1
6Y8-82521-31-00	PIGTAIL BUS HARNESS 4 PIN (1.8 M / 6 FT)	1
6Y9-83553-40-00	6Y9 DISPLAY CONVERSION HARNESS	1

* For double screen installation



DBW SINGLE ENGINE SECOND STATION SWITCH KIT
6X6-W0035-70-00

Parts Number	Description	Qty
6X6-82570-B0-00	STATION SELECTOR	2
6X6-82570-80-00	SINGLE ENGINE START/STOP SWITCH	1
6X6-82570-90-00	LANYARD SWITCH	1

* For dual station installation



6YC TWIN RIGGING KIT
6Y8-W0035-B2-00

Parts Number	Description	Qty
6YC-83710-00	6YC MULTI FUNCTION COLOUR DISPLAY	1
6Y8-81920-01-00	MULTI-HUB ASSY	2
6Y8-82553-01-00	MAIN BUS HARNESS 6 PIN (0.3 M / 1 FT)	1
6Y8-82582-11-00	TERMINAL CAP (4 PIN/DEVICE)	3
6Y8-82582-01-00	TERMINAL CAP (2 PIN/POWER)	1
6Y8-82521-11-00	PIGTAIL BUS HARNESS 4 PIN (0.6 M / 2 FT)	1
6Y8-82521-31-00	PIGTAIL BUS HARNESS 4 PIN (1.8 M / 6 FT)	2
6Y8-8356N-01-00	6Y8 GPS/FUEL WIRE (NMEA 0183)	1
6Y8-83553-01-00	SYSTEM POWER SUPPLY WIRE (2.4 M / 8 FT)	1
6X6-82570-40-00	TWIN ENGINE MAIN SWITCH PANEL	1
6X6-82570-60-00	TWIN ENGINE START/STOP PANEL	1
6X6-8258A-40-00	DBW MAIN HARNESS 16 PIN (12 M / 38 FT)	2
6YC-2819U-70-00	OWNER'S MANUAL	1
6YC-2819U-80-00	OWNER'S MANUAL	1

* DBW remote control box is required separately.



DBW TWIN ENGINES SECOND STATION SWITCH KIT
6X6-W0035-80-00

Parts Number	Description	Qty
6X6-82570-B0-00	STATION SELECTOR	2
6X6-82570-E0-00	TWIN ENGINES START/STOP SWITCH	1
6X6-82570-90-00	LANYARD SWITCH	1

* For dual station installation



DBW TRIPLE ENGINES SECOND STATION SWITCH KIT
6X6-W0035-90-00

Parts Number	Description	Qty
6X6-82570-B0-00	STATION SELECTOR	2
6X6-82570-F0-00	TRIPLE ENGINES START/STOP SWITCH	1
6X6-82570-90-00	LANYARD SWITCH	1

* For dual station installation



RIGGING KITS - FOR MECHANICAL REMOTE CONTROL

6Y8 SINGLE TACHO METER RIGGING KIT (ROUND)
6Y8-W0035-Y3-00

Parts Number	Description	Qty
6Y8-8350T-20-00	TACHOMETER ASSY (ROUND)	1
6Y8-81920-01-00	MULTI-HUB ASSY	1
6Y8-81920-11-00	INLINE HUB ASSY	1
6Y8-82553-21-00	MAIN BUS HARNESS 6 PIN (6.1 M / 20 FT)	1
6Y8-82521-41-00	PIGTAIL BUS HARNESS 4 PIN (2.7 M / 9 FT)	1
6Y8-82521-11-00	PIGTAIL BUS HARNESS 4 PIN (0.6 M / 2 FT)	1
6Y8-82582-11-00	TERMINAL CAP (4 PIN/DEVICE)	2
6Y8-83553-01-00	SYSTEM POWER SUPPLY WIRE (2.4 M / 8 FT)	1
6Y8-2819V-70-00	OWNERS MANUAL	1
6Y8-2819V-80-00	OWNERS MANUAL	1

* Mechanical remote control, switch panel and 10 pin main harness are required separately.



6Y8 SINGLE TACHO + SPEEDO/FMM RIGGING KIT (ROUND)
6Y8-W0035-E2-00

Parts Number	Description	Qty
6Y8-8350T-20-00	TACHOMETER ASSY (ROUND)	1
6Y8-83500-11-00	SPEEDO & FMM METER ASSY (ROUND)	1
6Y8-81920-01-00	MULTI-HUB ASSY	1
6Y8-81920-11-00	INLINE HUB ASSY	1
6Y8-82553-21-00	MAIN BUS HARNESS 6 PIN (6.1 M / 20 FT)	1
6Y8-82521-31-00	PIGTAIL BUS HARNESS 4 PIN (1.8 M / 6 FT)	1
6Y8-82521-11-00	PIGTAIL BUS HARNESS 4 PIN (0.6 M / 2 FT)	2
6Y8-82582-11-00	TERMINAL CAP (4 PIN/DEVICE)	1
6Y8-8356N-01-00	6Y8 GPS/FUEL WIRE (NMEA 0183)	1
6Y8-83553-01-00	SYSTEM POWER SUPPLY WIRE (2.4 M / 8 FT)	1
6Y8-2819K-R1-00	SET-UP MANUAL	1
6Y8-2819V-70-00	OWNERS MANUAL	1
6Y8-2819V-80-00	OWNERS MANUAL	1

* Mechanical remote control, switch panel and 10 pin main harness are required separately.



6YC SINGLE RIGGING KIT
6Y8-W0035-F1-00

Parts Number	Description	Qty
6YC-83710-00	6YC MULTI FUNCTION COLOUR DISPLAY	1
6Y8-81920-01-00	MULTI-HUB ASSY	1
6Y8-81920-11-00	INLINE HUB ASSY	1
6Y8-82553-21-00	MAIN BUS HARNESS 6 PIN (6.1 M / 20 FT)	1
6Y8-82521-31-00	PIGTAIL BUS HARNESS 4 PIN (1.8 M / 6 FT)	1
6Y8-82521-11-00	PIGTAIL BUS HARNESS 4 PIN (0.6 M / 2 FT)	1
6Y8-82582-11-00	TERMINAL CAP (4 PIN/DEVICE)	2
6Y8-8356N-01-00	6Y8 GPS/FUEL WIRE (NMEA 0183)	1
6Y8-83553-01-00	SYSTEM POWER SUPPLY WIRE (2.4 M / 8 FT)	1
6YC-2819U-70-00	OWNER'S MANUAL	1
6YC-2819U-80-00	OWNER'S MANUAL	1

* Mechanical remote control, switch panel and 10 pin main harness are required separately.



6YC COUNTER ROTATION RIGGING KIT
6Y8-W0035-G2-00

Parts Number	Description	Qty
704-48207-P1-00	704 TWIN TOP MOUNT REMOTE CONTROL	1
6YC-83710-00	6YC MULTI FUNCTION COLOUR DISPLAY	1
6Y8-82570-04-00	PANEL SWITCH ASSY	1
6Y8-81920-01-00	MULTI-HUB ASSY	2
6Y8-82553-31-00	MAIN BUS HARNESS 6 PIN (7.6 m / 25 ft)	1
6Y8-82521-11-00	PIGTAIL BUS HARNESS 4 PIN (0.6 M / 2 FT)	1
6Y8-82521-31-00	PIGTAIL BUS HARNESS 4 PIN (1.8 M / 6 FT)	1
6Y8-82521-41-00	PIGTAIL BUS HARNESS 4 PIN (2.7 M / 9 FT)	1
6Y8-82582-11-00	TERMINAL CAP (4 PIN/DEVICE)	3
6Y8-82582-01-00	TERMINAL CAP (2 PIN/POWER)	1
6Y8-8356N-01-00	6Y8 GPS/FUEL WIRE (NMEA 0183)	1
6Y8-83553-01-00	SYSTEM POWER SUPPLY WIRE (2.4 M / 8 FT)	1
6K1-8258A-40-00	10 PIN MAIN HARNESS 8 M (26 FT)	1
61B-8258A-01-00	10 PIN MAIN HARNESS 9.5 M (32 FT)	1
90149-05M05-00	SCREW	4
95380-05600-00	NUT, HEX	4
92990-05600-00	WASHER PLAIN	4
92990-05100-00	WASHER SPRING	4
6YC-2819U-70-00	OWNER'S MANUAL	1
6YC-2819U-80-00	OWNER'S MANUAL	1

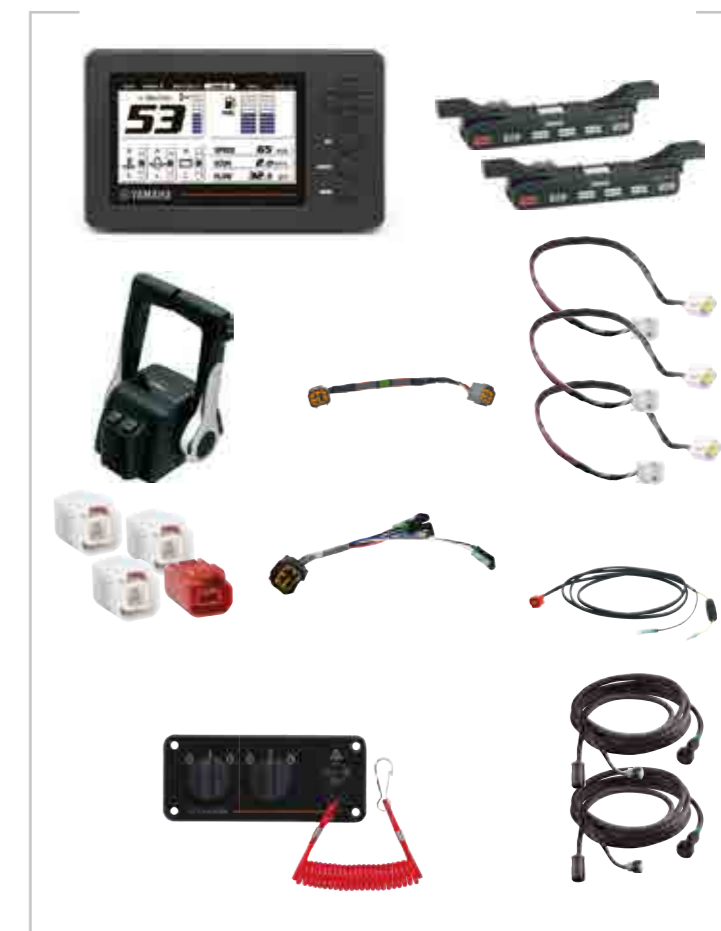

HARNESSES



DBW MAIN HARNESS (16-PIN)

Part Number	Length	Price
6X6-8258A-50-00	3.7 m (12 ft)	
6X6-8258A-60-00	5.2 m (17 ft)	
6X6-8258A-00-00	6 m (20 ft)	
6X6-8258A-10-00	7 m (23 ft)	
6X6-8258A-20-00	8 m (26 ft)	
6X6-8258A-30-00	10 m (32 ft)	
6X6-8258A-40-00	12 m (38 ft)	



MAIN BUS HARNESS (6-PIN)

Part Number	Length	Price
6Y8-82553-41-00	9.1 m (30 ft)	
6Y8-82553-31-00	7.6 m (25 ft)	
6Y8-82553-21-00	6.1 m (20 ft)	
6Y8-82553-11-00	4.6 m (15 ft)	
6Y8-82553-50-00	3.0 m (10 ft)	
6Y8-82553-01-00	0.3 m (1 ft)	



PIGTAIL BUS HARNESS (4-PIN)

Part Number	Length	Price
6Y8-82521-51-00	3.6 m (12 ft)	
6Y8-82521-41-00	2.7 m (9 ft)	
6Y8-82521-31-00	1.8 m (6 ft)	
6Y8-82521-21-00	0.9 m (3 ft)	
6Y8-82521-11-00	0.6 m (2 ft)	
6Y8-82521-01-00	0.3 m (1 ft)	



DBW 2ND STATION HARNESS 1

Primary harness (3-4-6 pin)

Part Number	Length	Price
6X6-8258A-G1-00	5 m (16 ft)	
6X6-8258A-H1-00	8 m (26 ft)	
6X6-8258A-J1-00	12 m (38 ft)	



DBW 2ND STATION HARNESS 2

Secondary harness (2-12 pin)

Part Number	Length	Price
6X6-8258A-B1-00	5 m (16 ft)	
6X6-8258A-D1-00	8 m (26 ft)	
6X6-8258A-F1-00	12 m (38 ft)	



SYSTEM POWER SUPPLY WIRE

Supplies electric power from the key switch to the digital network
6Y8-83553-01-00



MULTI-HUB

Distributes the digital signal and electric power to the gauges and the other hubs. (Multi-Hub includes ending resistor cap 6Y8-85371-01)
6Y8-81920-01-00



SINGLE HUB (INLINE HUB)

6Y8-81920-11-00



6Y9 MULTI SENSOR HARNESS

To connect multi sensor (6Y9) to Hub
6Y9-83553-60-00



6Y9 DISPLAY CONVERSION HARNESS

To connect 6Y9 LCD colour display to Hub
6Y9-83553-40-00



DBW MAIN BUS ADAPTOR HARNESS

To connect DBW control to Hub
6Y9-83553-00-00



GREY MAIN BUS CONNECTION CAP WITH RESISTOR (6-PIN)

Ending resistor. Cap for "BUS" on Multi Hub.
6Y8-85371-01-00



RED POWER CONNECTION CAP (2-PIN)

Cap for "POWER" on Multi Hub.
6Y8-82582-01-00



WHITE PIGTAIL CONNECTION CAP (4-PIN)

Cap for "DEVICE" on Multi Hub.
6Y8-82582-11-00



6Y9 FUEL WIRE

To connect up to 4 tanks to 6Y9 colour display
6Y9-8356N-10-00



6Y9 GPS WIRE

To connect GPS to 6Y9 colour display
6Y9-8356N-01-00



6Y8 GPS/FUEL WIRE

To connect GPS/Tanks to 6Y8 gauge
6Y8-8356N-01-00

HARNESSES



MAIN HARNESS (7-PIN / 10-PIN)

Pin	Part Number	Length	Price
7-pin	688-82586-50-00	5 m (16 ft)	
10-pin	688-8258A-50-00	5 m (16 ft)	
10-pin	688-8258A-60-00	6 m (19 ft)	
10-pin	688-8258A-70-00	7 m (23 ft)	
10-pin	6K1-8258A-40-00	8 m (26 ft)	
10-pin	61B-8258A-01-00	9.5 m (32 ft)	



MAIN HARNESS EXTENSION (7-PIN / 10-PIN)

Pin	Part Number	Length	Price
7-pin	688-82586-11-00	2 m (7 ft)	
7-pin	688-82586-31-00	3 m (10 ft)	
10-pin	688-8258A-10-00	2 m (7 ft)	
10-pin	688-8258A-30-00	3 m (10 ft)	



703 CONTROL BOX MAIN HARNESS

Pin	Part Number	Length	Price
7-pin	688-82586-21-00	5 m (16 ft)	
10-pin	688-8258A-20-00	5 m (16 ft)	



TRIM & OIL HARNESS

Part Number	Length	Price
6Y5-83653-00-00	5 m (16 ft)	
6Y5-83653-10-00	6 m (19 ft)	
6Y5-83653-20-00	7 m (23 ft)	
6Y5-83653-30-00	8 m (26 ft)	
6Y5-83653-40-00	9 m (29 ft)	
6Y5-83653-50-00	10.5 m (34 ft)	



MULTI-FUNCTION TILLER HANDLE

Our convenient 6X4 Multi-function Tiller Handle is available as an option for mid-range outboard models.

- Ergonomic design and longer, larger-diameter throttle grip
- Contoured, composite-coated lever for smooth, comfortable shifting
- Easy access Power Trim and Tilt switch for on-the-go operation
- Neat and conveniently positioned LED engine warning lamp
- Key switch and STOP switch easily accessible from the handle
- Built-in NEUTRAL switch and buzzer for simple rigging

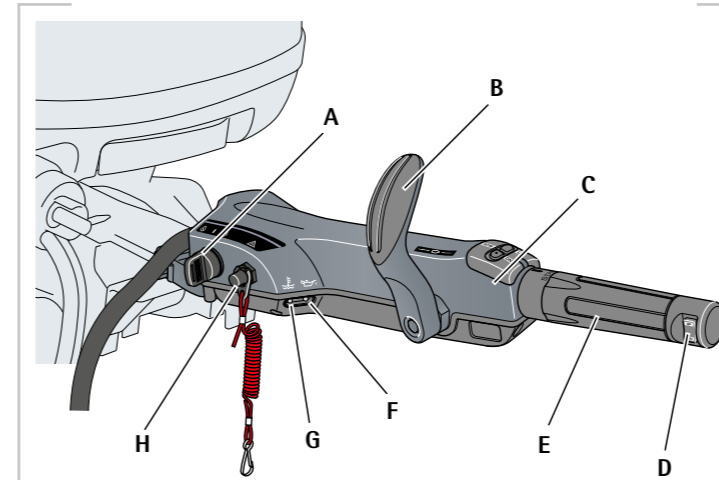

1 - TILLER HANDLE - MAIN BODY

Applicable to F30 - F115.

- A - Engine start/stop
- B - Shift control
- C - Variable trolling switch
- D - PTT Control
- E - Throttle Control
- F - Low oil pressure alert
- G - Overheat alert
- H - Emergency stop lanyard



2 - FITTING KIT

Fitting kits may differ by outboard model, as shown in the table below

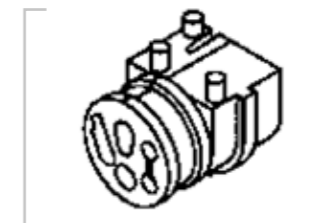

3 - ENGINE GROMMET

Some outboard models require an engine grommet to fit additional wire leads.

4 - YCOP ATTACHMENT KIT

Required to activate YCOP immobilizer installed with Multifunction Tiller Handle.

Part No	Description	Price	Qty
6Y8-82553-01-00	Main bus harness 0.3 M (1 FT)		1
6Y8-82521-51-00	Pigtail bus harness 3.6 M (12 FT)		1
6Y8-82117-00-00	Pigtail bus with power lead		1
6Y8-81920-11-00	Single hub		2
6Y5-83553-M0-00	Wire harness		1



OUTBOARD MODEL	1*		2		3		4	
	TILLER HANDLE - MAIN BODY	PRICE	FITTING KIT	PRICE	ENGINE GROMMET FOR YCOP	PRICE	Y-COP ATTACHMENT KIT	PRICE
F25A/F25D/FT25F	6X4-42103-08-00		Included					
F30B/F40F			6X4-42102-81-00		(Not Required)			
F50F/F50H/FT50G/FT50J/ F60C/F60F/FT60D/FT60G			6X4-42102-91-00		6C5-42725-50-00			
F70A	6X4-42103-64-00				(Not Required)		6Y8-W0035-C0-00	
F80B/F100D			6X4-42102-A1-00		68V-42725-20-00			
F115A			6X4-42102-B1-00					
F115B/F130A			6X4-42102-C0-00		(Not Required)			

1* F25A/F25D/FT25F are without C/F/G - depending on models - Consult your dealer

Y-COP (YAMAHA CUSTOMER OUTBOARD PROTECTION)



Y-COP (Yamaha Customer Outboard Protection) is a simple, push-button immobilizer for your engine, so that just like your car, it only starts when you want it to. The following table shows the applicable engines:

MODEL	SERIAL NUMBER
F30B/F40F	All engines
F50F	6C1-1030972 -
F50H	All engines
FT50G	6C2-1008760 -
FT50J	All engines
F60C	6C5-1038579 -
F60F	All engines
FT60D	6C6-1013739 -
FT60G	All engines
F70A	All engines
F80B	6D7-1010597 -
F100D	6D9-1014011 -
F115A	68V-1113062 -
FL115A	68W-1004693 -
F115B	All engines
FL115B	All engines
F130A	All engines
F150A	63P-1106291 -
FL150A	64P-1013389 -
F150D	All engines
FL150D	All engines
F175A	All engines
F200F/F200G	All engines
FL200F/FL200G	All engines
F225F/F250D/F300B	All engines
FL225F/FL250D/FL300B	All engines
F350A	6AW-1004795 -
FL350A	6AX-1002906 -

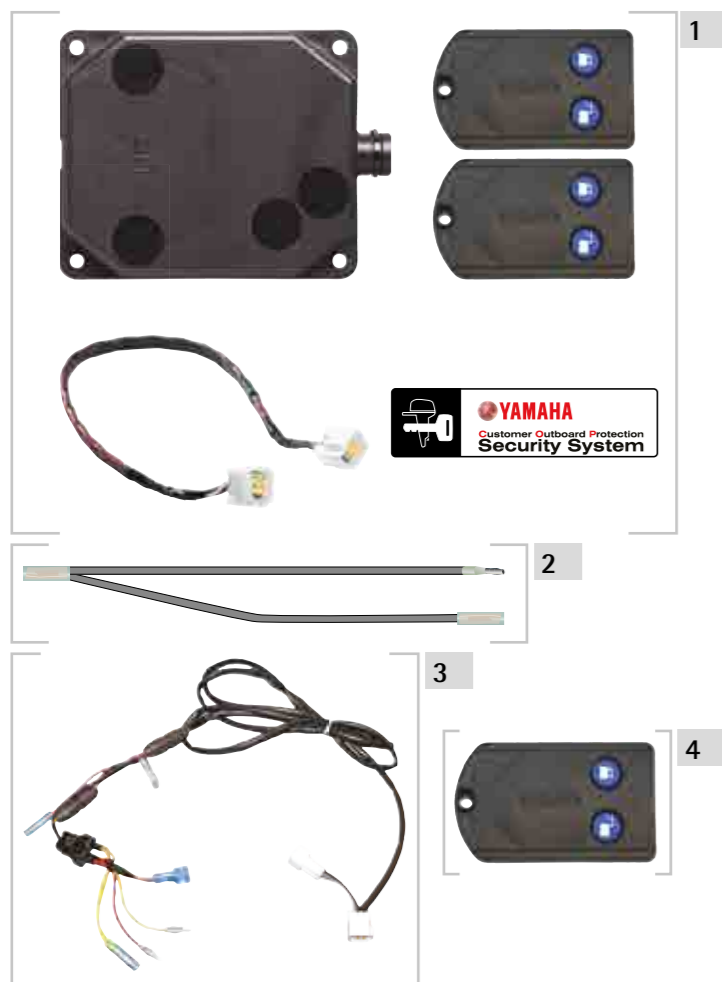

PLEASE CONTACT YOUR DEALER TO FIND OUT IF YOUR ENGINE IS ALREADY EQUIPED WITH Y-COP.

#	PART NUMBER	DESCRIPTION	QTY	PRICE
1	Y-COP Kit	6Y8-W0035-J0-00	1	
Kit is including below parts:				
	6Y8-86254-02-00	Receiver unit (with remote transmitter)	1	
	90167-06M00-00	Pan-Tapping Screw	4	
	97880-06035-00	Pan-Head Screw	4	
	90201-06M30-00	Plate Washer	8	
	95780-06300-00	Nylon Nut	4	
	6Y8-82521-11-00	Pigtail Bus Harness 4 Pin (0.6 M / 2 FT)	1	
	6Y8-48277-00-00	YCOP decal	4	
	6Y8-28107-96-00	Y-COP Owner's and Installation Manual	1	
	Part Number	Description		Price
2	6H5-81315-00-00	Y-COP power distribution wire (for multiple engines/mechanical control)		
3	6Y8-81315-00-00	Y-COP power distribution wire (for multiple engines/DBW control)		
4	6AA-86261-00-00	Remote transmitter (for replacement)		

Steering & Steering Systems



STEERING WHEELS



#	PART NUMBER	DIAMETER (MM)		PRICE
1	YMM-24001-00-WH	335	STEERING WHEEL WHITE LONG SPOKE	
2	YMM-24001-00-BK	335	STEERING WHEEL BLACK LONG SPOKE	
3	YMM-24002-00-BK	342	STEERING WHEEL BLACK 4-SPOKE	
4	YMM-24005-00-BK	350	STEERING WHEEL BLACK 5-SPOKE	
5	YMM-24005-00-GY	342	STEERING WHEEL GREY 5-SPOKE	
6	YMM-24003-00-BK	350	STEERING WHEEL BLACK	
7*	YMM-24007-00-BS	350	STEERING WHL BLACK/SILVER METAL	
8	YMM-24004-00-BK	280	STEERING WHEEL BLACK SMALL	
9	YMM-24006-00-CH	345	STEERING WHEEL CHROME 5-SPOKE	
10*	YMM-24007-00-BK	350	STEERING WHEEL BLACK	
11*	YMM-24008-00-BS	350	STEERING WHEEL LUXE BLACK/SILVER	
12*	YMM-24009-00-BK	350	STEERING WHEEL BLACK/BLACK GRIP	
-	YMM-24000-01-00	-	HUB FOR STEERING WHEELS (X63)	

* To fit these wheels, the special hub (part number YMM-24000-01-00) is also required.

MECHANICAL STEERING SYSTEMS



Y12 Helm/Bezel



Y25 Bezel



Y24 Helm/Bezel



Y22 Helm (fast-connect system)



Y23 Helm (non self-centring fast-connect system)

All these systems are highly responsive and are designed and built to our exacting standards of safety, durability and comfort. The Y22 and Y23 helms (or Y20 kit) can be used for all types of applications. Our Y23 helm has a special non self-centring mechanism, which means the wheel won't return automatically to the straight ahead position after a turn. Both these helms have to be installed with a Y25 Bezel, which is available in 20° and 90° versions.

Number of turns lock-to-lock: Y12 - approx 2.5 Y22/Y23 - approx 3.8 Y24 - approx 3

The Y12 (or Y10 kit) is for smaller boats with engines below 40kW (or below 55hp). Y24 can be applied if a simpler, more conventional system is required.

Part Name	Part Number	Price
Y12 Helm/Bezel	YMM-22400-00-00	
Y22 Helm (fast-connect system)	YMM-22500-00-00	
Y23 Helm (non self-centring fast-connect)	YMM-22500-10-00	
Y24 Helm/Bezel	YMM-22510-00-00	
Y25 Bezel (90° version)	YMM-22550-00-00	
Y25 Bezel (20° version)	YMM-22551-00-00	

Y10 COMPLETE KIT FOR ENGINES BELOW 40KW (OR BELOW 55HP) INCLUDING Y11, Y12 AND STEERING WHEEL YMM-24003-00-BK

FEET	CM	Part Number	Part Name	Price
8'	244	YMM-22208-00-00	CABLE Y10 STEERING 8	
9'	274	YMM-22209-00-00	CABLE Y10 STEERING 9	
10'	305	YMM-22210-00-00	CABLE Y10 STEERING 10	
11'	335	YMM-22211-00-00	CABLE Y10 STEERING 11	
12'	366	YMM-22212-00-00	CABLE Y10 STEERING 12	
13'	396	YMM-22213-00-00	CABLE Y10 STEERING 13	
14'	427	YMM-22214-00-00	CABLE Y10 STEERING 14	
15'	457	YMM-22215-00-00	CABLE Y10 STEERING 15	

Y11 STEERING CABLE (TO BE USED WITH Y12)

FEET	CM	Part Number	Part Name	Price
7'	213	YMM-22007-00-00	CABLE Y11 STEERING 7	
8'	244	YMM-22008-00-00	CABLE Y11 STEERING 8	
9'	274	YMM-22009-00-00	CABLE Y11 STEERING 9	
10'	305	YMM-22010-00-00	CABLE Y11 STEERING 10	
11'	335	YMM-22011-00-00	CABLE Y11 STEERING 11	
12'	366	YMM-22012-00-00	CABLE Y11 STEERING 12	
13'	396	YMM-22013-00-00	CABLE Y11 STEERING 13	
14'	427	YMM-22014-00-00	CABLE Y11 STEERING 14	
15'	457	YMM-22015-00-00	CABLE Y11 STEERING 15	
16'	488	YMM-22016-00-00	CABLE Y11 STEERING 16	
17'	518	YMM-22017-00-00	CABLE Y11 STEERING 17	
18'	549	YMM-22018-00-00	CABLE Y11 STEERING 18	
20'	610	YMM-22020-00-00	CABLE Y11 STEERING 20	

Y20 COMPLETE KIT FOR ALL ENGINES (INCLUDING Y21, Y22, Y25 AND STEERING WHEEL YMM-24007-00-BK

FEET	CM	Part Number	Part Name	Price
10'	305	YMM-22310-00-00	CABLE Y20 STEERING 10	
11'	335	YMM-22311-00-00	CABLE Y20 STEERING 11	
12'	366	YMM-22312-00-00	CABLE Y20 STEERING 12	
13'	396	YMM-22313-00-00	CABLE Y20 STEERING 13	
14'	427	YMM-22314-00-00	CABLE Y20 STEERING 14	
15'	457	YMM-22315-00-00	CABLE Y20 STEERING 15	
16'	488	YMM-22316-00-00	CABLE Y20 STEERING 16	
17'	518	YMM-22317-00-00	CABLE Y20 STEERING 17	

Y21 STEERING CABLE (TO BE USED WITH Y22/Y23/Y24)

FEET	CM	Part Number	Part Name	Price
7'	213	YMM-22107-00-00	CABLE Y21 STEERING 7	
8'	244	YMM-22108-00-00	CABLE Y21 STEERING 8	
9'	274	YMM-22109-00-00	CABLE Y21 STEERING 9	
10'	305	YMM-22110-00-00	CABLE Y21 STEERING 10	
11'	335	YMM-22111-00-00	CABLE Y21 STEERING 11	
12'	366	YMM-22112-00-00	CABLE Y21 STEERING 12	
13'	396	YMM-22113-00-00	CABLE Y21 STEERING 13	
14'	427	YMM-22114-00-00	CABLE Y21 STEERING 14	
15'	457	YMM-22115-00-00	CABLE Y21 STEERING 15	
16'	488	YMM-22116-00-00	CABLE Y21 STEERING 16	
17'	518	YMM-22117-00-00	CABLE Y21 STEERING 17	
18'	549	YMM-22118-00-00	CABLE Y21 STEERING 18	
19'	579	YMM-22119-00-00	CABLE Y21 STEERING 19	
20'	610	YMM-22120-00-00	CABLE Y21 STEERING 20	
21'	640	YMM-22121-00-00	CABLE Y21 STEERING 21	
22'	671	YMM-22122-00-00	CABLE Y21 STEERING 22	
23'	701	YMM-22123-00-00	CABLE Y21 STEERING 23	
24'	732	YMM-22124-00-00	CABLE Y21 STEERING 24	
25'	762	YMM-22125-00-00	CABLE Y21 STEERING 25	

ACCESSORIES FOR MECHANICAL SYSTEMS

Some outboard models require additional accessories for the connection between the steering cable and the engine.

Description	Part Number	Price
Clamp block to support steering cables (aluminium and stainless steel)	YMM-22601-00-00	
Splash well mounting support for steering cables (corrosion resistant)	YMM-22602-00-00	
Clamp block to support steering cables (corrosion resistant painted steel)	YMM-22603-00-00	
Clevis for YMM-22601-00-00, YMM-22602-00-00 or YMM-22603-00-00	YMM-22610-00-00	
Clevis for YMM-22601-00-00, YMM-22602-00-00 or YMM-22603-00-00	YMM-22611-00-00	



STEERING GUIDE ATTACHMENT KITS

These kits are required for connection between the steering cable end and the outboard's steering hook.

Model	Part Number	Price
F8C(-03/2007)/FT8D(-03/2007)	68T-61350-00-00	
F8C(04/2007-)/FT8D(04/2007-)/F9.9J/FT9.9L	68T-61350-10-00	
9.9F/15F/F9.9C/FT9.9D/F15A	63V-61350-00-00	
FT9.9A/F9.9B	6G8-61350-00-00	
F15C/F20B	6AH-61350-00-00	
20C/20D/25B/25N/25V/30D/30G/40Q	689-61350-02-00	
F25D/FT25F/F30B/F40F	6BG-61350-00-00	
40V/50H/F50A/FT50C	63D-61350-00-00	
F20A/F25A/FT25B/F30A/F40B/C/D/F50F/H/F60A/C/F/FT50G/J/FT60B/D/G/F70A/40X	65W-61350-00-00	
50G/60F/70B/75C/90A/75A/85A	688-61350-10-00	
F80A/B/F100A/D	67F-61350-00-00	
F115B/F130A	6EK-61350-00-00	
F100B/F115A/F150A/F175A/V4/V6 (2 Et 4 stroke)	6E5-61350-02-00	

Tie-Bar Kit	Part Number	Price
F115 to F300 (V6) Adjustable distance: 600-800mm	6E5-61301-01-00	



STEERING HOOKS

Model	Type	Part Number	Price
Universal Steering Hook (A50) for engines between 5 and 25hp 6C/D/8C/9.9D/15D/40Q		YMM-21220-00-00	
F6A/F8C/FT8D/F9.9C/FT9.9D/F9.9F/FT9.9G/F9.9J/FT9.9LF15A/9.9F/15F	Ball post type, not for F8B/F9.9A/B/25J	676-48511-02-00	
F8A/B/F9.9A/B/25J/30D ('87-'96)	Steering guide type	63V-48511-01-00	
F8A/B/F9.9A/B/25J/30D ('87-'96)	Ball post type	6G8-48511-10-00	
F15C/F20B	Steering guide type	6G8-48511-20-00	
20C('85-'96) 20D/25B/25D/N/30A/G ('85-'89)	Ball post type/Steering guide type	6AH-48511-01-00	
20D/25N ('90-'00)	Ball post type/Steering guide type	689-48511-02-00	
20D/25N ('01-') 25J/30D ('94-')		6L2-48511-00-00	
25J/30DETO ('99-'01)	Steering guide type	6J8-48511-01-4D	
F20A/F25A/F25D/FT25B/FT25F/F30A/F30B/F40B/F40F/F50F/F50H/FT50B/ FT50G/FT50J/F60A/F60C/F60F/FT60B/FT60D/FT60G/F70A/40X	Steering guide type	65W-48511-01-00	
25B/50G/60F/70B	Steering guide type	6H3-48511-52-00	
25B/Q/40H/50D/50G/60F/70B/75A/80A/85A/90A/55B ('95-')	Ball post type	688-48511-01-4D	
55B ('92-'94)	Steering guide type	688-48511-51-1D	
55B ('95-'98)	Steering guide type	688-48511-52-00	
55B ('90-'94) 75A/85A ('90-'93)	Ball post type	688-48511-01-4D	
75C/90A	Steering guide type	688-48511-12-00	
25Q/40H/50D	Steering guide type	6H4-48511-51-4D	
40V/Y/F40A/F45A/50H/F50A/B/FT50B/C		63D-48511-01-00	
F80A/F80B/F100A/F100D	Steering guide type	67F-48511-01-00	
F115A	Steering guide type	68V-48511-01-00	

Filters and Fuel Accessories



FUEL FILTERS

Keeping your fuel clean really is an important issue where boating is concerned. Contaminated fuel affects performance and can increase the wear and tear on your engine. The trouble is that countless small dirt particles are already in the fuel before it gets anywhere near your boat - and that's where Yamaha Water Separating Fuel Filters come in. They are designed to be the most efficient systems available for removing dirt before it can enter the pumps and injection system. Without one of these, dirty, unfiltered fuel could block the internal fuel passages, causing the engine to run poorly - or even to fail.

Instead of the standard 35/27-micron filter, the Yamaha 10-micron filter will protect your engine by removing dirt, water and small foreign particles. These superior 10-micron filters are strongly recommended for all engines, especially HPDI and EFI models.

However, it's important to choose a fuel filter with the right capacity for your engine and to regularly maintain it, to avoid reduced performance and engine damage. A simple rule of thumb is to ensure that the litres-per-hour (LPH) of the filter is greater than that of the engine. This figure can be found in your owner's manual.

Remember, a filter that is too big or too good cannot cause problems, but one that is too small or dirty can restrict fuel flow, possibly resulting in engine failure.

GENUINE YAMAHA WATER SEPARATOR/FUEL FILTER:

Corrosion-resistant and specifically designed to fit into smaller areas. Recommended for outboards up to 70HP.

Filter features:

- Manufactured from lightweight resin material.
- Comes with In & Out connectors (can be swapped)
- Clear bowl to allow easy checking of flow and filtering
- 10-micron filter element
- Fluid capacity of 60cc
- Water separation capacity of 99% or more



WATER SEPARATOR FILTERS

Description	Horsepower	Part Number	Price
Water Separator Filter	Up to 70HP	907-94469-09-00	
Water Separator Filter by 40 pieces bulk	Up to 70HP	907-94469-08-00	
Water/Fuel Separator Filter 10-micron including connectors in 8/08mm	Up to 175HP	907-94469-05-00	
Water/Fuel Separator Filter 10-micron including connectors in 10/08mm	Up to 350HP	907-94469-07-00	
Replacement Filter 10-Micron (including new O-ring)		907-94468-79-00	
Replacement Filter-10 Micron		907-94469-13-00	

FILTERS

Description	Part Number	Price
Complete filter kit for engines up to 50hp to 10-micron, 95 litres/hour	YMM-2W095-01-00	
Complete filter kit for engines between 50hp and 115hp 10-micron, 114 litres /hour	YMM-2W114-00-00	
Replacement element for filter kit between 50hp and 115hp	YMM-2E114-00-00	
Complete filter kit for engines over 115hp 10-micron, 227 litres/hour	YMM-2W227-01-00	
Replacement element for filter kit over 115hp	YMM-2E227-01-00	
Complete filter kit for twin engine installation or professional Use 10-micron, 341 litres/hour	YMM-2W341-01-00	
Replacement element for filter kit for twin engine installation or professional use	YMM-2E341-01-00	

(Note: A filter is never "too big". A larger filter will last longer than one which is "just large enough")



Connectors



Filters



Replacement filters

CONNECTORS

Description	Part Number	Price
Connectors for YMM-2W095-00-00 and YMM-2W227-00-00 (1/4" NPT ports):		
Straight fitting for 6.5mm hose	YMM-2FS06-00-00	
Straight fitting for 8mm hose	YMM-2FS08-00-00	
Straight fitting for 10mm hose	YMM-2FS10-00-00	
Elbow fitting for 8mm hose	YMM-2FE08-00-00	
Elbow fitting for 10mm hose	YMM-2FE10-00-00	
Connectors for YMM-2W341-00-00 (3/8" NPT ports):		
Straight fitting for 8mm hose	YMM-2SF08-00-00	
Straight fitting for 10mm hose	YMM-2SF10-00-00	

FUEL TANKS AND ACCESSORIES

FUEL TANK:

Description	Part Number	Price
Yamaha 12 litre plastic tank (length 363mm x width 265mm x height 230mm)	6YL-24201-05-00	
Yamaha 25 litre plastic tank (length 536mm x width 362mm x height 233mm)	6YK-24201-03-00	

FUEL PICKUP:

Description	Part Number	Price
12 litres	979-51242-61-00	
25 litres	979-51242-62-00	

FUEL CAP:

Description	Part Number	Price
12 litre tank	MAR-COMBI-CP-12	
25 litre tank with fuel gauge	MAR-COMBI-CP-25	
25 litre tank without fuel gauge	6YK-24610-10-00	

JERRY CAN:

Description	Part Number	Price
5 litre Jerry can	YMM-5LTRE-00-11	
No-spill spout for 5 litre Jerry can	YMM-NSPSP-T0-00	
1 litre Jerry can	YMM-10LTR-E0-10	

FUEL PIPE JOINT (FEMALE):

Description	Part Number	Price
For 6mm OM side	6G1-24305-05-00	
For 6mm Tank side	6Y1-24305-06-00	
For 8mm OM side	6E5-24305-06-00	
For 8mm Tank side	6Y2-24305-06-00	

FUEL PIPE JOINT (MALE):

Description	Part Number	Price
For 6mm	6G1-24304-02-00	
For 8mm	6E5-24304-10-00	

PRIMARY PUMP:

Description	Part Number	Price
For 6mm	6Y1-24360-52-00	
For 8mm	6Y2-24360-52-00	
6mm F4B/F5A/F6C under the cowl	6BX-24360-00-00	

FUEL HOSE:

Description	Part Number	Price
6mm 30m	90890-56878-00	
8mm 30m	90790-77001-00	

FUEL PIPE COMPLETE:

Description	Part Number	Price
6mm, 3m, both ends with joint	6Y1-24306-55-00	
6mm, 3m, with one joint	6Y4-24306-84-00	
8mm, 3m, both ends with joint	6Y2-24306-56-00	
8mm, 3m, with one joint	6Y2-24306-45-00	
6mm, 3m, Permanent Sealed, both ends with joint	6YL-24306-54-00	
8mm, 3m, Permanent Sealed, both ends with joint	6YK-24306-44-00	

Note : Fuel pipes and related parts presented in this section are intended for portable use only.



Other Rigging & Accessories



NEW GATEWAY

Enables simple connection of NMEA-compatible devices to the Yamaha Digital Network. Multi-protocol for both 6Y8 and 6Y9 connections.

6Y9-8A2D0-20-00



NEW ANALOGUE GAUGE INTERFACE (AGI)

Enables simple connection of conventional analog gauges to the Yamaha Digital Network. Multi-protocol both for both 6Y8 and 6Y9 connections.

6Y9-8A2D0-30-00



ELECTRONIC COOLING WATER PRESSURE SENSOR

Enables the cooling water pressure to be displayed on the 6Y8 tachometer and 6Y9 colour display.

F30 to F115	60V-8A4L0-13-00
F150 and up	69J-8A4L0-14-00



ELECTRONIC SPEED SENSOR KIT

Enables speed information to be displayed on the 6Y8 tachometer and 6Y9 colour display.

F30 to F300 (V6) 60V-8A4L1-12-00



SPEEDOMETER TUBING

8 m	6Y5-83557-10-00
100 m	6Y5-83557-40-00



TRANSOM MOUNTED MULTI-SENSOR

For 6Y9 Display 6Y9-83688-00-00
See page 72 for installation

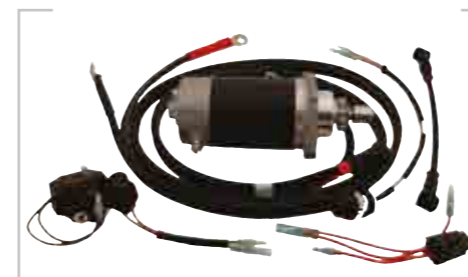

ELECTRIC STARTER KIT FOR F6A/F8/FT8/F9,9/FT9,9

Convert a manual start engine into electric start. F8F/FT8G/F9,9J/FT9,9L require Rectifier/Regulator.

F6A/F8C/FT8D	6DR-W8180-00-00
F8F/FT8G/F9,9J/FT9,9L	6DR-W8180-00-00

BATTERY CABLE (FOR BATTERY CHARGING)

Allows electrical power to be drawn from the engine. This battery cable is for battery charging only - not suitable for the starter motor. F9,9J/FT9,9L require a Rectifier/Regulator.

Description	Part No	QTY	Price
Battery Cable	68T-81949-00-00	1	
Fuse (10A-BL)	67F-82151-40-00	2	
Stay, Fuse Box	68T-82171-01-00	1	
Puller, Fuse	67F-2812A-00-00	1	
Washer	92990-06600-00	1	

RECTIFIER/REGULATOR (F9,9L/FT9,9L)

Allows to have stable DC current from the engine. Required for Electric Starter Kit 6DR-W8180-00-00 or individual battery cable 68T-81949-00-00.

Description	Part No	QTY	Price
Rectifier/Regulator Assembly	68T-81960-00-00	1	
Bolt	97080-06012-00	1	
Clamp	90465-10098-00	2	



BATTERY ISOLATOR LEADS

Allows the starter battery to be charged first, when other battery is being used for onboard accessories.

Description	Part No	Price
F150A	68F-81949-02-00	
F175 to F350 (except V6 4.2L)	69J-81949-02-00	
F225F/F250D/F300B V6 4.2L	6CE-81949-00-00	



LIGHTING COIL KIT FOR F4B/F5A/F6C

Allows electrical power to be drawn from the engine

6BX-W8130-A0-00

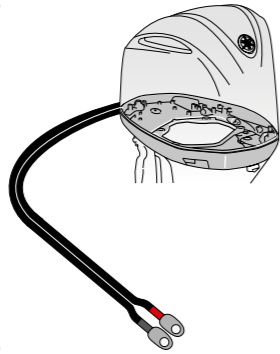

ENGINE BATTERY CABLE

Used to connect Yamaha Outboard Motors to 12V batteries.

Description	Part No	Price
F(T)50 - F(T)60	6C5-82105-01-00	
F70	6C5-82105-U1-00	
F80/F100/F115/F130A	68V-82105-J1-00	
F150	63P-82105-01-00	
F175/F200F/F200G	6DA-82105-01-00	
V6 3.3L	6P2-82105-02-00	
V6 4.2L	6CB-82105-01-00	
F350A	6AW-82105-01-00	



FUSE CARTRIDGES

Amps	Part No	Price
50	63P-82151-00-00	
60	6P2-82151-00-00	
80	61A-82151-00-00	
100	6CE-82151-00-00	

YAMAHA BATTERY BOXES

Size	Max Battery Size	Part Number	Price
Small	Length 277mm x Width 186mm	YMM-BTBX0-00-24	
Large	Length 327mm x Width 186mm	YMM-BTBX0-00-27	



BATTERY CHARGERS

Unique battery charging technology: Fully automatic switch mode charger that analyses the state of the battery, charges and automatically switches to maintenance charging when ready. Includes battery testing, fault detection and float maintenance. Always ensuring a full charge to prolong battery life time. Designed for safety: Spark-free, protected from reverse polarity connections and short-circuit proof. Light and compact: Easy to store and handle. Yamaha Approved: Tested and approved by Yamaha service engineers to fit and work perfectly with the Yamaha Outboards range. Quick connection: Combine it with YEC quick connectors - the Built-in Panel Plug, Charger Indicator and Indicator Panel 150 - for reading the charge condition of your battery and/or for easier access between your Yamaha's battery and the YEC-9 or YEC-50 charger.

Battery Charger	Part Number	Price
1 - YEC-9: 6-step charger that can charge the battery of your Yamaha outboard	YME-YEC09-EU-00	
2 - YEC-50: 8-step charger that can charge the battery of your Yamaha outboard.	YME-YEC50-EU-00	



WAVERUNNER BATTERY

Dry charge WaveRunner battery.

Description	Part No	Price
Battery YUASA YB16CLB (19AH)	EU0821100900	



BS BATTERY

New sealed and factory activated battery line by BS.
- No acid handling
- Ready Et easy to use
- Multi-positional fitment

Description	Part No	Max Battery Size
12V - 19Ah - 260A	907983BB16CL	175 x 100 x 175
12V - 18Ah - 270A	907983BTX20L	175 x 87 x 155



ENGINE FLUSH KIT

This extremely useful piece of equipment connects in seconds to your garden hose and allows you to flush out harmful salt and sand. It can also be used for out-of-water operation for tune-ups.

For F4/F5/F6 engines	ABB-FLUSH-JD-00
For F8 to F200 engines	ABB-MOTOR-FL-SH



RIGGING HOSE

Keep your cables protected and uncluttered with a Rigging Hose. Yamaha Hoses are tough yet flexible and are constructed from crush-resistant, UV-protected material to ensure a longer life span. Hoses are mounted using a chromium-plated copper or plastic bracket and come in black, gray or metallic blue colours.

Black	25ft/7,62m	ABB-RIGHS-BK-25
Gray	25ft/7,62m	ABB-RIGHS-GY-25
Metallic blue	25ft/7,62m	ABB-RIGHS-BE-25

RIGGING GROMMETS

These handy devices replace rubber engine grommets on bigger engines and provide positive attachment without the need for clamps. They can be threaded directly onto one end of a rigging hose with Transom Brackets at the other end.

115-250 (2-stroke)	MAR-GROMM-ET-01
F150	MAR-GRMMT-F1-50
F200B/C-F250A/B	MAR-GRMMT-LG-4S



TRANSOM PLATES

Yamaha recommend these transom plates for boats with engines from 60hp and up.

V4/V6 engines aluminium 10mm	YMM-09TP0-00-01
V8 engines aluminium 10mm	YMM-09TP0-00-02

TRANSOM BRACKETS

The tough plastic bracket is easy to install by just threading the Rigging Hose onto it. It requires no clamp, yet provides positive engagement. Use with the rigging Grommet on the other end for quick, easy rigging. When the chromium plated copper "through transom bracket" is used, the rigging hose is fitted with the clamp.

Chrome transom bracket with 2 anodised stainless steel clamps	ABA-THRUT-RA-SM
Plastic transom bracket	MAR-THRUT-RS-M2



TRANSOM BOLTS

Outboard	Part Number	Thread	Total length	Thread length	No Thread length	Boat transom thickness (*)	Price
F25D - F300B	90101-12M51-00	M12	95mm	60mm	35mm		
	90101-12M65-00	M12	105mm	50mm	55mm		
	90101-12M03-00	M12	115mm	60mm	55mm	55-65mm	
	90101-12M05-00	M12	130mm	75mm	55mm	65-75mm	
F350A	901-01120-47-00	M12	150mm	75mm	75mm	75-95mm	
	90101-12031-00(**)	M12	150mm	75mm	75mm	75-95mm	
	90101-12036-00(**)	M12	170mm	75mm	95mm	95-115mm	

* Reference data

** High tension bolts for F350A



YAMAHA TIE DOWNS :

Both include two 25mm x 1.80m straps rated for 540 kg.

Type	Part number	Price
Blue, cam-lock buckle	ACC-OSS58-40-28	
Blue, ratcheting	ACC-OSS58-40-30	

FENDER SOCKS

These high specification fender socks have been produced in a UV and saltwater resistant material. The socks come in black with a white Yamaha logo.

Description	Part Number	Price
0 - 6 metres (fits 13 x 50cm fender)	YMM-09FSO-00-01	
6 - 10 metres (fits 15 x 60cm fender)	YMM-09FSO-00-02	



YAMAHA ADULTS LIFEVEST ORANGE 100N

Self-righting capacity. Head is supported above neck. Buoyancy provided by polythylene foam. Outershell 100% polyester. Fluorescent orange for optimum visibility. 100cm2 retro-reflecting stripes.

Description	Part Number	Price
LIFEVEST ORANGE 100N SMALL	D16LVADTB60S	
LIFEVEST ORANGE 100N MEDIUM	D16LVADTB60M	
LIFEVEST ORANGE 100N LARGE	D16LVADTB60L	
LIFEVEST ORANGE 100N XLARGE	D16LVADTB61L	



YAMAHA INFLATABLE LIFEVEST 165N

Buoyancy: Rated 150 N, actual buoyancy 165 N (33 g CO² gas bottle). Ergonomic shape: Short on chest and cutaway sides. Rounded neck for superior comfort. Hardwearing and flexible outer shell with reflective piping. Visibility of inflated jacket: Yellow air chamber + 300 cm² retro-reflecting tapes. Backstrap: 40 mm polypropylene: ensures perfect body fit when lifevest is inflated. CE EN ISO 12402-3 12401

Description	Part Number	Price
INFLATABLE LIFEVEST 165N	D16INFLVB400	



OUTBOARD MOTOR COVERS

There is no better way of protecting your Outboard than a genuine Outboard motor cover. These breathable covers are designed to fit like a second skin for every engine in the range from the 2.5hp upwards. Smart and stylish, they are manufactured from a highly durable waterproof fabric resistant to rot, mildew and UV exposure.

Outboard Model	Part Number	Price
F2.5A	YMM-09100-00-00	
F4A	YMM-09101-00-00	
F4B/F5A/F6C	YMM-09101-01-00	
F6A/F8C/F9.9F/F9.9J	YMM-09102-00-00	
F15C/F20B/F20C	YMM-09103-00-00	
F20D/F25D	YMM-09104-00-00	
F30B/F40F	YMM-09105-00-00	
F40D/F50F/F60C	YMM-09106-00-00	
F40G/F50H/F60F	MAR-MTRCV-FS-70	
F70A	YMM-09113-00-00	
F80/F100	YMM-09107-00-00	
F115A	YMM-09108-00-00	
F115B/F130A	MAR-MTRCV-11-50	
F150A	YMM-09109-00-00	
F150D/F174AF200F-G	MAR-MTRCV-F2-01	
F225F/F250D/F300B	MAR-MTRCV-F4-2L	
F300A/F350A	YMM-09112-00-00	



NEW TRAILER SUPPORT

The Yamaha Trailer Support stops your outboard motor moving excessively whilst your boat is being towed on a trailer. Quickly and easily installed over the port trim rod, this support prevents long term damage to both the boat and the engine. One Yamaha Trailer Support will provide adequate support for the F115A up to V6 series. V8 models will require two supports. Please note this product does not work with the F115B or F130A.

Description	Part Number	Price
TRAILER SUPPORT	MARMTSPTYM10	



YAMAHA KIDS LIFEVEST ORANGE 100N

100 Newton category jacket. Self-righting capacity, keeps the child's head out of the water. Buoyancy: polythylene foam. Large roll-around collar with increased buoyancy providing added comfort and improved head support. Visibility: Bright orange colour and retro-reflecting tapes. Comfortable to wear: front floatation panel is split in 2 for increased comfort, adjustable crotch piece. Closure: adjustable waist belt with plastic clip, hem tightening drawstring, neck closing strap. Grab handle and loop in the back to attach a safety line.

Description	Part Number	Price
LIFEVEST ORANGE 100N 1-2YRS	D16LVKIDB605	
LIFEVEST ORANGE 100N 2-5YRS	D16LVKIDB607	
LIFEVEST ORANGE 100N 5-8YRS	D16LVKIDB611	
LIFEVEST ORANGE 100N 8-10YRS	D16LVKIDB613	



TILT LIMITER

The tilt limiter will help improve customer satisfaction in applications where the top cowling would come in contact with the boat at full tilt. (Adjacent list shows applicable engine serial numbers) Check with your dealer for installation validation following owner manual instruction.

Model	Starting Serial Number	Tilt Limiter Kit	Price
F50H	6C1-1047118-	6C5-825EY-00-00	
F60F	6C5-1053953-	6C5-825EY-00-00	
FT50J	6C2-1014367-	6C5-825EY-00-00	
FT60G	6C6-1020951-	6C5-825EY-00-00	
F70A	6CJ-1019836-	6C5-825EY-00-00	
F80B	6D7-1014351-	6D8-825EY-00-00	
F100D	6D9-1020147-	6D8-825EY-00-00	
F115A	68V-1124466-	63P-825EY-01-00	
FL115A	68W-1005001-	63P-825EY-01-00	
F115B	All engine	63P-825EY-01-00	
FL115B	All engine	63P-825EY-01-00	
F130A	All engine	63P-825EY-01-00	
F150A	63P-1106291-	63P-825EY-01-00	
FL150A	64P-1013389-	63P-825EY-01-00	
F150D	All engine	63P-825EY-01-00	
FL150D	All engine	63P-825EY-01-00	
F175A	All engine	63P-825EY-01-00	
F200F	All engine	63P-825EY-01-00	
FL200F	All engine	63P-825EY-01-00	
F200G	All engine	6CE-825EY-00-00	
FL200G	All engine	6CE-825EY-00-00	
F225F	6CL-1001428-	6CE-825EY-00-00	
FL225F	6CM-1000253-	6CE-825EY-00-00	
F250D	6CG-1003350-	6CE-825EY-00-00	
FL250D	6CH-1000945-	6CE-825EY-00-00	
F300B	6CE-1005964-	6CE-825EY-00-00	
FL300B	6CF-1002506-	6CE-825EY-00-00	

SPRAY PAINT

Scratches can cause rust or other types of damage. Fix them quickly and effectively with our high-quality, durable Yamaha aerosols and primers. They've been developed specifically for marine use and offer the best colour match for Yamaha outboards. Box 6 x 400ml Cans.

Description	Part Number	Price
Ocean Blue (for OM until 1983)	YMM304000B10	
Marine Blue (for OM from 1983 until 1993)	YMM30400MB10	
Bluish Grey Metal (for OM from 1994)	YMM30400GM10	
Bluish Grey Metal 1 (for F30 to F350 OM from 2009)*	YMM30400GM10	
Bluish Grey Metal 2 (F2.5 to F25)	YMM30400GM20	
Dark Blue (for origin OM)	YMM30400DB10	
Top Coat	YMM30400TC10	
Filling Primer	YMM30400FP10	
Zincprimer (anti-corrosive for aluminium parts)	YMM30400ZP10	
Propeller White (All aluminium prop)	YMM30400PW10	

* For previous model colour codes consult your Yamaha Dealer

OUTBOARD MOTOR KEYS

300 and 700 series - Key cover replacement
703-82577-00-00



300 and 700 series - 18mm Switch cap replacement
6K1-82532-00-00



OM KEY NUMBER:	PART NUMBER	PRICE	MATCHING CAP KEY	PART NUMBER	PRICE
111	90890-55957-00		Cap Key	676-82577-00-00	
112	90890-55958-00		Cap Key	676-82577-00-00	
113	90890-55959-00		Cap Key	676-82577-00-00	
121	90890-55960-00		Cap Key	676-82577-00-00	
122	90890-55961-00		Cap Key	676-82577-00-00	
123	90890-55962-00		Cap Key	676-82577-00-00	
371	90890-55868-00		Cap Key	703-82577-00-00	
372	90890-55869-00		Cap Key	703-82577-00-00	
373	90890-55870-00		Cap Key	703-82577-00-00	
374	90890-55871-00		Cap Key	703-82577-00-00	
375	90890-55872-00		Cap Key	703-82577-00-00	
376	90890-55873-00		Cap Key	703-82577-00-00	
377	90890-55874-00		Cap Key	703-82577-00-00	
378	90890-55875-00		Cap Key	703-82577-00-00	
379	90890-55876-00		Cap Key	703-82577-00-00	
380	90890-55877-00		Cap Key	703-82577-00-00	
381	90890-55878-00		Cap Key	703-82577-00-00	
382	90890-55879-00		Cap Key	703-82577-00-00	
383	90890-55880-00		Cap Key	703-82577-00-00	
384	90890-55881-00		Cap Key	703-82577-00-00	
385	90890-55882-00		Cap Key	703-82577-00-00	
386	90890-55883-00		Cap Key	703-82577-00-00	
387	90890-55884-00		Cap Key	703-82577-00-00	
388	90890-55885-00		Cap Key	703-82577-00-00	
389	90890-55886-00		Cap Key	703-82577-00-00	
390	90890-55887-00		Cap Key	703-82577-00-00	
451	90890-55820-00		Cap Key	676-82577-00-00	
452	90890-55821-00		Cap Key	676-82577-00-00	
453	90890-55822-00		Cap Key	676-82577-00-00	
454	90890-55823-00		Cap Key	676-82577-00-00	
455	90890-55824-00		Cap Key	676-82577-00-00	
456	90890-55825-00		Cap Key	676-82577-00-00	
457	90890-55826-00		Cap Key	676-82577-00-00	
458	90890-55827-00		Cap Key	676-82577-00-00	
459	90890-55828-00		Cap Key	676-82577-00-00	
460	90890-55829-00		Cap Key	676-82577-00-00	
461	90890-55830-00		Cap Key	676-82577-00-00	
462	90890-55831-00		Cap Key	676-82577-00-00	
463	90890-55832-00		Cap Key	676-82577-00-00	
464	90890-55833-00		Cap Key	676-82577-00-00	
465	90890-55834-00		Cap Key	676-82577-00-00	
466	90890-55835-00		Cap Key	676-82577-00-00	
467	90890-55836-00		Cap Key	676-82577-00-00	
468	90890-55837-00		Cap Key	676-82577-00-00	
469	90890-55838-00		Cap Key	676-82577-00-00	
470	90890-55839-00		Cap Key	676-82577-00-00	
721	90890-56004-00		Cap Key	703-82577-00-00	
727	90890-56005-00		Cap Key	703-82577-00-00	
730	90890-56006-00		Cap Key	703-82577-00-00	

OM KEY NUMBER:	PART NUMBER	PRICE	MATCHING CAP KEY	PART NUMBER	PRICE
731	90890-56007-00		Cap Key	703-82577-00-00	
732	90890-56008-00		Cap Key	703-82577-00-00	
733	90890-56009-00		Cap Key	703-82577-00-00	
741	90890-56010-00		Cap Key	703-82577-00-00	
747	90890-56011-00		Cap Key	703-82577-00-00	
750	90890-56012-00		Cap Key	703-82577-00-00	
751	90890-56013-00		Cap Key	703-82577-00-00	
752	90890-56014-00		Cap Key	703-82577-00-00	
753	90890-56015-00		Cap Key	703-82577-00-00	
821	90890-56016-00		Cap Key	676-82577-00-00	
827	90890-56017-00		Cap Key	676-82577-00-00	
830	90890-56018-00		Cap Key	676-82577-00-00	
831	90890-56019-00		Cap Key	676-82577-00-00	
832	90890-56020-00		Cap Key	676-82577-00-00	
833	90890-56021-00		Cap Key	676-82577-00-00	
841	90890-56022-00		Cap Key	676-82577-00-00	
847	90890-56023-00		Cap Key	676-82577-00-00	
850	90890-56024-00		Cap Key	676-82577-00-00	
851	90890-56025-00		Cap Key	676-82577-00-00	
852	90890-56026-00		Cap Key	676-82577-00-00	
853	90890-56027-00		Cap Key	676-82577-00-00	

NEW FOR 2015 - 2 KEY SET INCLUDING PLASTIC CAP KEY.

OM Key number:	Part number	Price
457	6X6-82511-09-A1	
462	6X6-82511-09-A2	
463	6X6-82511-09-A3	
827	6X6-82511-09-A4	
832	6X6-82511-09-A5	
833	6X6-82511-09-A6	
847	6X6-82511-09-A7	
852	6X6-82511-09-A8	
853	6X6-82511-09-A9	



ANODES

The materials and build quality of a Yamaha engine means it's already highly resistant to corrosion. The addition of a self-sacrificing anode will improve this even further.

CYLINDER ANODES

Table with 3 columns: Outboard Model, Part Number, Price. Lists various Yamaha outboard models and their corresponding cylinder anode part numbers.

Table with 3 columns: Outboard Model, Part Number, Price. Lists Yamaha outboard models and their corresponding stern-drive diesel anode part numbers.

STERN-DRIVE DIESEL ANODES

Table with 3 columns: Type / Engine Model, Part Number, Price. Lists different types of stern-drive diesel anodes and their part numbers.

F300A/F350A (V8) ANODES

Table with 3 columns: Type, Part Number, Price. Lists various F300A and F350A V8 anodes and their part numbers.

TAB TRIM ANODES

Table with 3 columns: Outboard Model, Part Number, Price. Lists Yamaha outboard models and their corresponding tab trim anode part numbers.

IMPELLERS

This vital component of the water pump ensures a continuous supply of the correct amount of coolant to the engine.

Table with 3 columns: Outboard/Engine Model, Part Number, Price. Lists various Yamaha impeller part numbers and their corresponding models.

THERMOSTATS

A thermostat regulates the perfect engine operating temperature. A correctly performing thermostat prevents engine over-cooling which can cause dilution of the oil and reduction of filtration.

Table with 3 columns: Outboard Model, Part Number, Price. Lists various Yamaha outboard models and their corresponding thermostat part numbers.

PRIMARY FUEL FILTERS

Fuel filters and replacement cartridges with high power filtering to block any small particles in the fuel.

Table with 3 columns: Outboard Model, Part Number, Price. Lists various Yamaha outboard models and their corresponding primary fuel filter part numbers.

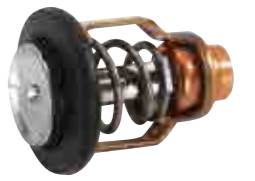



NGK SPARK PLUGS

These provide the ultimate performance for your engine. They're high-quality, reliable and their advanced materials and design provide superior anti-fouling characteristics, which reduce carbon build-up over a wide heat range. "V Type" plugs include a thin centre electrode tip, which is made of precious metal for added corrosion and oxidation resistance. The result: fast, sure starts and less misfiring, even in the coldest weather.

- Ribbed to eliminate flash-over and improve performance
- Highest quality ceramic insulators improve heat dissipation and electrical insulation to provide long term durability
- More Gaskets for peak performance
- Deep-seated copper core provides maximum engine efficiency at high and low speeds
- Projected insulator precision-engineered to prevent fouling and misfiring
- Nickel alloy tip prevents fouling, maximises performance and extends plug life

OUTBOARD MODEL	PART NUMBER	NGK REF.	PRICE
(L)Z150P / Z150Q (VMAX)	94702-00405-00	BKR6EKU	
Z175G / (L)Z200N / Z200P (VMAX) / (L)Z250D / Z250F (VMAX) / (L)Z300A	94702-00404-00	BKR7EKU	
2B	94702-00249-00	BR5HS	
F2,5A / F4A	94701-00248-00	BR6HS	
3A / F6A / F8C / FT8D / F9,9F / F9,9J / FT9,9G / FT9,9L	94702-00274-00	BR6HS10	
4A / 5C / 20C / 25D / 40X	94701-00110-00	BR7HS	
6C / 8C / 9,9D / 9,9F / 15D / 15F / 20D / 25N / 25V / 25B / 30D / 40H / 40V	94702-00271-00	BR7HS10	
40Q	94701-00195-00	BR8HS	
30G / 50D / 50G / 50H / 55B / 60F / 70B / 75A / 75C / 80A / 85A / 90A / 100A / 115A / 115B / 115C / 140A / 150A / 150C / 150F / 175A / 175B / 175D / 200A / 200B / 200F / 200G / 225D / (L)250A / (L)250G	94702-00247-00	BR8HS10	
130B / 140B / 200C / 225B / 250B / 225G (VMAX)	94701-00309-00	BR9HS10	
F8B	94701-00300-00	CR5HS	
F9,9A / F9,9B	94701-00282-00	CR6HS	
F60A / FT60B	94701-00406-00	DPR5EA9	
F9,9C / FT9,9D / F15A / F25A / FT25B / F30A / F40A / F40B / F50A / FT50B / FT50C	94701-00375-00	DPR6EA9	
F15C / F20B / F25D / FT25F / F30B / F40F / F50F / F50H / FT50G / FT50J / F60C / F60F / FT60D / FT60G	94702-00418-00	DPR6EB9	
F80A / F80B / F100A / F100B / F100D / F(L)150A / F(L)200A / F(L)225A	94702-00391-00	LFR5A11	
F(L)115A / F175A / F(L)200C / F(L)200F / F(L)200G / F(L)225B / F225C / F(L)250A / F(L)250B / F(L)300A / F(L)350A / F(L)225F / F(L)250D / F(L)300B	94702-00400-00	LFR6A11	
F4B / F5A / F6C	94702-00372-00	CR6HSB	
F70A	94702-00429-00	LKR7E	
F(L)115B	94702-00437-00	LKR6E	
STERN-DRIVE ESSENCE	94701-00365-00	BR6FS	
WAVERUNNER MODEL	PART NUMBER	NGK REF.	PRICE
XL800 / XLT800 / GP800 / WB800 / GP800R	94701-00204-00	BR8ES	
XLT1200 / XL1200LTD / GP1200R / GP1300R	94702-00396-00	BR8ES11	
SJ650 / 650T / 650TL / 650TX / FX1 / PRO TX700 / WB700 / XL700 / WVT700 / W.RAIDER 760 / WVT760 / XL760 / WB760 / GP760 / W.RAIDER 1100 / WVT1100 / SUV1200 / GP1200 / XL1200	94701-00195-00	BR8HS	
SJ700 / W.RAIDER 700	94701-00110-00	BR7HS	
FX140 / FX140 CRUISER / FX160 / FX160 CRUISER / FX1100 HO / HO CRUISER / VX SERIES / V1	94702-00409-00	CR9EB	
FX SHO / FX SHO CRUISER 2008--2014 / FX HO / FX HO CRUISER 2009--2014 / FZR / FZS 2009--2013 / VX1800 2011--2014	94702-00427-00	LFR6A	
FX SVHO / FX SVHO CRUISER / FZS/FZR 2014	94702-0043-500	LFR7A	



OIL FILTERS

The oil filter is an essential component that contributes to the lifetime of the engine. Compromising on the quality or replacement timing of this part may result in serious technical issues and we always recommend the use of a genuine YAMAHA oil filter. Build quality and high filtering power ensure your engine receives the very highest levels of safety.

Outboard Model	Part Number	Price
F8A/B/F9,9A/B/FT9,9A (--1989)	6G8-13411-01-00	
F8A/F9,9A/B/FT9,9A (1990--)	6G8-13440-00-00	
F9,9C 2000-- / FT9,9D 2000--/F15A 2000--/F20A 2000--/F25A 2000--/FT25B/ F30A/F40A 2000--/F40B '01--/F50A '99--'05 /F50F --05/FT50B 2000-- / FT50C --05/FT50G --05/F60A --05/F60C --05/FT60B --05/FT60D --05/ F80A 2000-- /F80B/F100A 2000-- / F100B/F100D/F(L)115A / F115B	5GH-13440-30-00	
F15C 07-- / F20B 07-- / F25D / FT25F / F30B / F40F / F50A 06-- / FT50C 06-- / FT60B 06-- / F50F 06-- / FT50G 06-- / F60A 06-- / F60C 06-- / FT60D 06-- / F50H / F60F / FT50J / FT60G / F70A / VX CRUISER / DELUXE 08--11 / VX SPORT 08 / FX / FX HO / FX HO CRUISER 08	5GH-13440-50-00	
F9,9C '98 / FT9,9D '99 / F15A '98 / F20A '98 / F25A '98/'99 / F40A '99 / F40B 2000 / F50A '95-- '98 / FT50B '96--'99 / F80A/F100A '99	3FV-13440-20-00	
F(L)150A/ F175A /F(L)200A/ F(L)200C / F(L)200F / F(L)200G /F(L)225A/ F(L)225B /F225C / F(L)250A /F(L)250B / FX SHO / FX SHO CRUISER / FX HO CRUISER / FZR / FZS	69J-13440-03-00	
F(L)300A / F(L)350A / F(L)225F / F(L)250D / F(L)300B	N26-13440-02-00	
WaveRunner Model	Part Number	Price
FX140 / FX140 CRUISER / FX160 / FX160 CRUISER / FX-H.O CRUISER / FX-HIGH OUTPUT / VX 1100 SPORT & DELUXE	5GH-13440-30-00	
Stern Drive Model	Part Number	Price
ME 370 STI / ME 372 STI / ME 420 STI / ME 422 STI / ME 432 STI	YD9-09153-00-02	



AIR FILTERS

WaveRunner Model	Part Number	Price
Air filter for: "SJ 700"	62T-14451-00-00	
Air filter for: "VX"	6D3-14451-00-00	
Air filter for: "FX 140 / FX 1100"	6B6-14451-01-00	
Air filter for: "FX 1800 / FZR / FZS"	65S-E4451-00-00	
Stern Drive Model	Part Number	Price
Air filter for "ME 372 / ME 422 / ME 432"	N51-14451-00-00	



ENGINE TIMING BELTS

The timing belt is a vital element of your 4-stroke engine, used to synchronize the movement of valves with the pistons. For 2-stroke HPDI engines the timing belt is used to drive the high pressure fuel pump. The timing belt should be replaced every five years or every 1000 hours of operation (1st maturity reached).

Outboard Model	Part Number	Price	Remarks
F6A --04 / F8C --04 / FT8D --04 / F9,9F / F9,9J / FT9,9G / FT9,9L	68T-46241-00-00		
F6A 05-- / F8C 05-- / FT8D 05--	68T-46241-00-00		
F8B/FT9,9A/F9,9B	6G8-46241-00-00		
F9,9C/FT9,9D/F15A	66M-46241-00-00		
F15C / F20B	6AH-46241-00-00		
F25A/FT25B/F30A/F40B	65W-46241-00-00		
F40A/F50A/FT50B/C/F60A/FT60B	62Y-46241-00-00		
F25D / FT25F / F30B / F40F / F50F/FT50G/ FT50J / F50H / F60C/ F60F/FT60D / FT60G / F70A	6C5-46241-00-00		
F80A/B/F100A/B/D/F(L)115A/	67F-46241-00-00		
F(L)115B	6EK-W4624-00-00		With rotor bolts
F(L)150A	63P-46241-00-00		
F(L)200A/F(L)225A/	69J-46241-00-00		
F(L)200C / F(L)225B / F225C / F(L)250A / F(L)250B	6P2-46241-01-00		
(L)Z150P / Z150Q / Z175G / (L)Z200N / Z200P (---2003)	68F-46241-00-00		
(L)Z150P / Z150Q / Z175G / (L)Z200N / Z200P (2004---)	68F-46241-10-00		
(L)Z250D/Z250F/L)Z300A	60V-46241-00-00		
F175A /F(L)200F / F(L)200G	6DA-W4624-00-00		
F(L)300A / F(L)350A	6AW-W4624-00-00		With rotor bolts
F(L)225F / F(L)250D / F(L)300B	6CB-W4624-00-00		With rotor bolts
Stern Drive Model	Part Number	Price	Remarks
ME422	YU1-35681-91-95		
ME422 / ME432	6TA-12444-00-00		
ME370 / ME372	6TC-12444-00-00		
ME370 / ME372	6TC-12445-01-00		

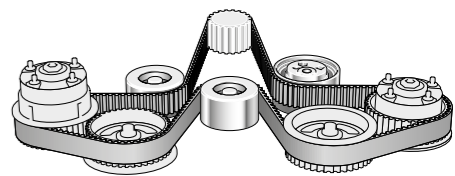

Rigging Order Guide



INDEX

Description	Page
MULTI-FUNCTION TILLER HANDLE	
Single Engine (6Y8 Gauge + 6X4 Multi-function Tiller Handle)	59
MECHANICAL REMOTE CONTROL	
Single Engine (6Y8 Gauges + 703 Side Mount)	60
Single Engine (6Y8 Gauges + 6X3 Flush Mount)	61
Single Engine (6Y8 Gauges + 704 Top Mount)	62
Twin Engine (6YC Gauges)	63
DBW REMOTE CONTROL (MAIN STATION)	
Single Engine (6YC Gauges + 6X7 Flush Mount)	64
Single Engine (6Y9 Colour Display + 6X7 Flush Mount)	65
Single Engine (6YC Gauges + 6X6 Top Mount)	66
Single Engine (6Y9 Colour Display + 6X6 Top Mount)	67
Twin Engine (6YC Gauges)	68
Twin Engine (6Y9 Colour Display)	69
Triple Engine (6Y9 Colour Display)	70
DBW REMOTE CONTROL (2ND STATION)	
Single Engine	71
Twin Engine	72
Triple Engine	73
MULTI-SENSOR	
For 6Y9 Colour Display	74
For 6Y8 Gauges (DBW Remote Control)	74
For 6Y8 Gauges (Mechanical Remote Control)	74
GATEWAY/AGI	
Gateway	75
Analogue Gauge Interface (AGI)	75
Y-COP	
Y-COP with Multi-function Tiller Handle	76
Y-COP with Single Engine	77
Y-COP with Twin/Triple Engines (Mechanical Remote Control)	78
Y-COP with Twin/Triple Engines (DBW Remote Control)	79

MULTI-FUNCTION TILLER HANDLE

SINGLE ENGINE (6Y8 GAUGE + 6X4 MULTI-FUNCTION TILLER HANDLE)

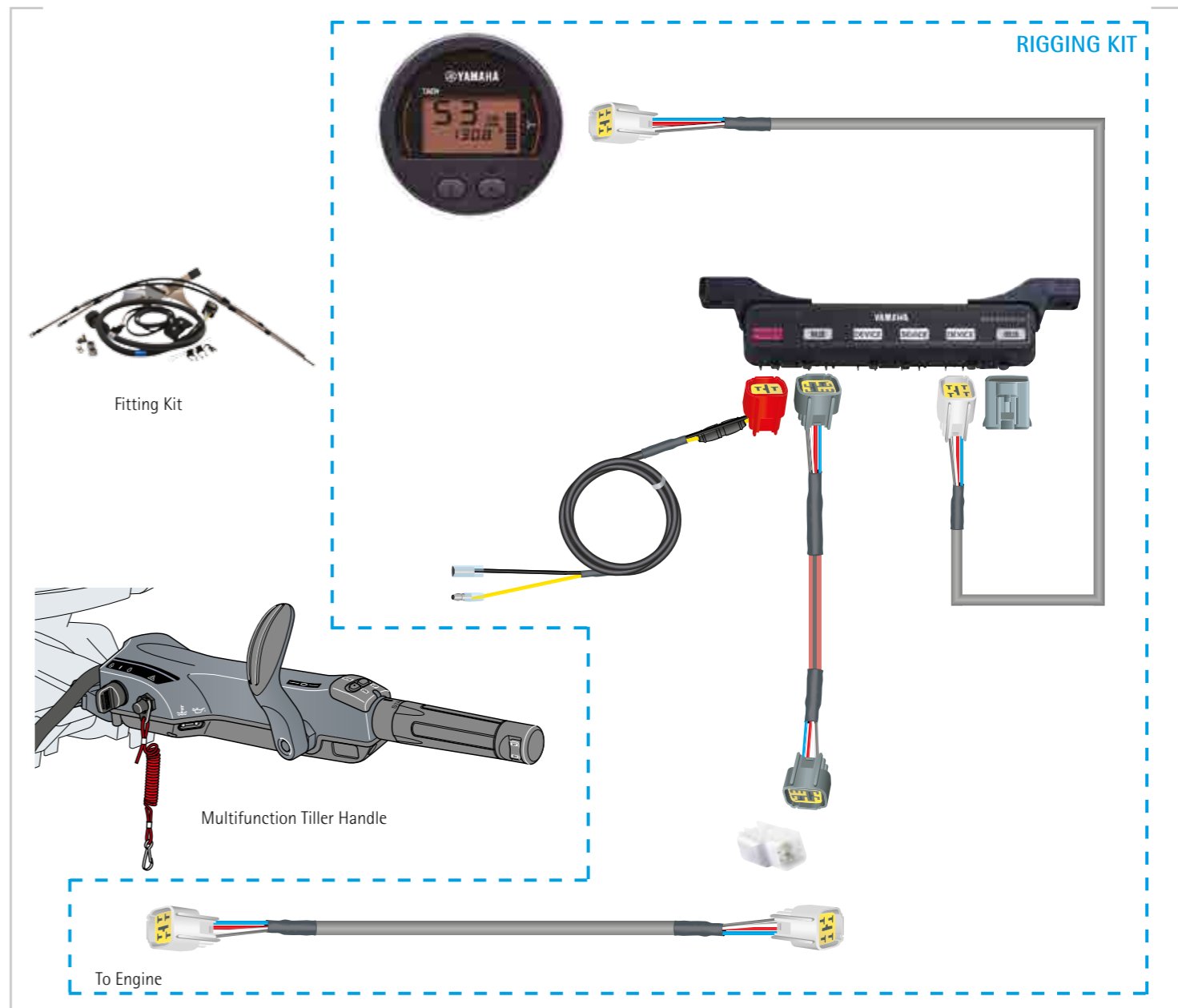

Part Number	Description	Qty	Price
RIGGING KIT			
6YR-W0035-Y3-00	6Y8 Round Tachometer Kit	1	
MULTI-FUNCTION TILLER HANDLE			
6X4-42103-64-00	6X4 Multi-function Tiller Handle	1	
TILLER HANDLE FITTING KIT			
6X4-42102-81-00	F30B/F40F		
6X4-42102-91-00	F50H/FT50J/F60F/FT60G/F70A		
6X4-42102-A1-00	F80B/F100D	1	
6X4-42102-B1-00	F115A		
6X4-42102-C0-00	F115B		

For Y-COP, Multi-sensor and Gateway installations please see page 72-77

MECHANICAL REMOTE CONTROL

SINGLE ENGINE (6Y8 GAUGES + 703 SIDE MOUNT)

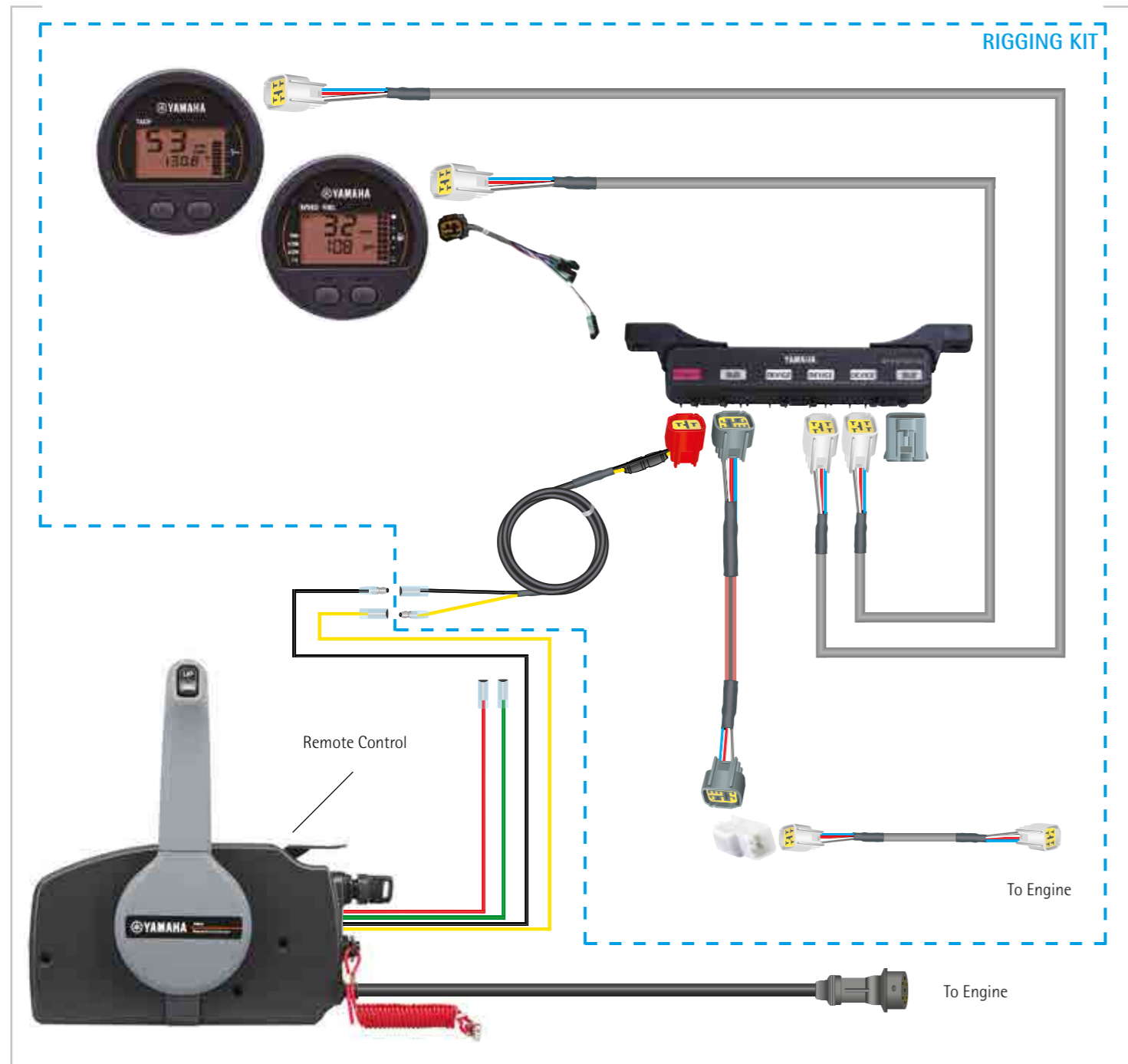

Part Number	Description	Qty	Price
RIGGING KIT			
6YR-W0035-Y3-00	6Y8 Round Tachometer Kit		
6Y8-W0035-E2-00	6Y8 Round Tacho + Speedo/FMM Kit (Shown above)	1	
6Y8-W0035-F1-00	6YC Kit		
REMOTE CONTROL BOX			
703-48207-21-00	703 Side mount remote control	1	

SINGLE ENGINE (6Y8 GAUGES + 6X3 FLUSH MOUNT)

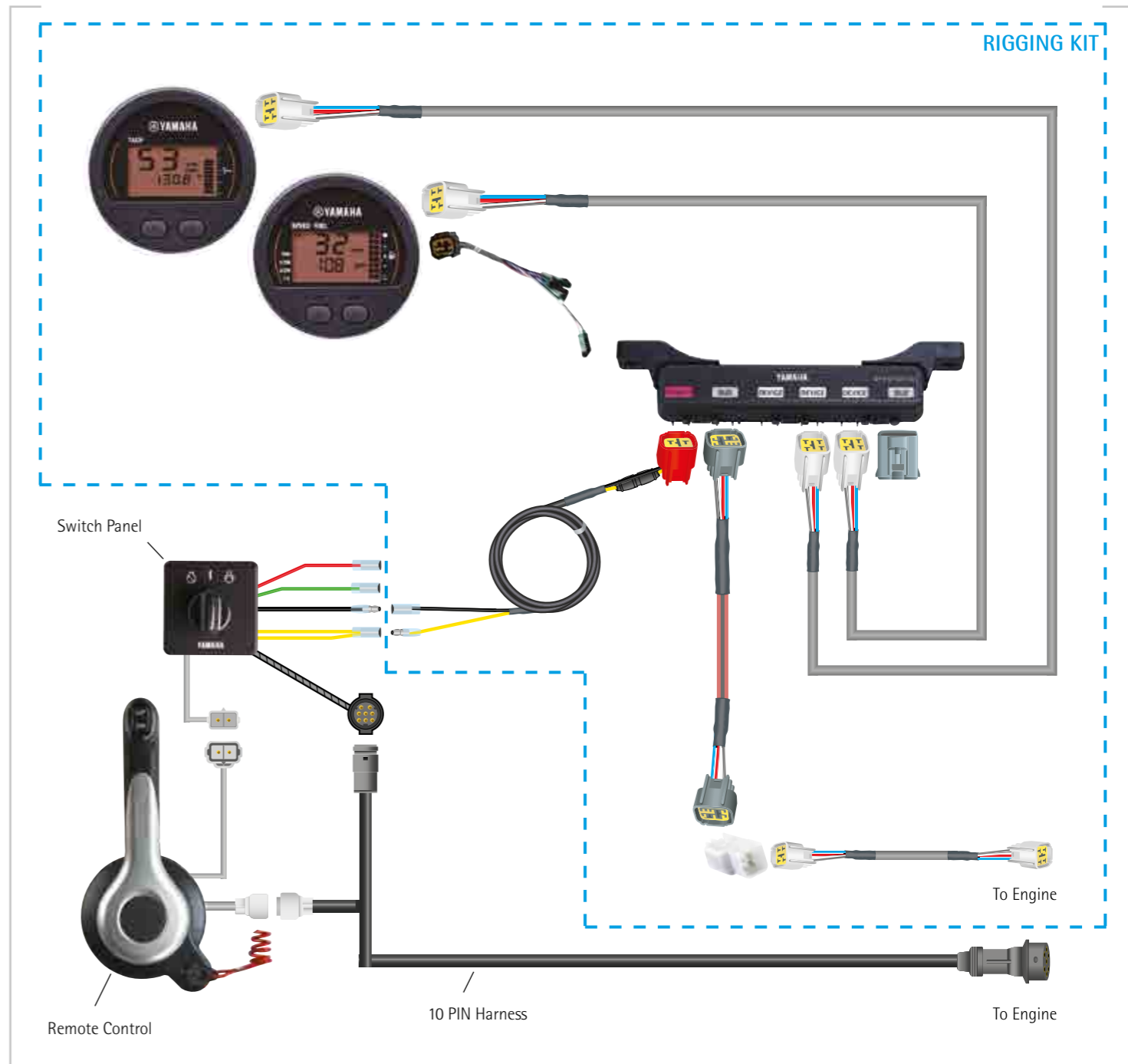

Part Number	Description	Qty	Price
RIGGING KIT			
6YR-W0035-Y3-00	6Y8 Round Tachometer Kit		
6Y8-W0035-E2-00	6Y8 Round Tacho + Speedo/FMM Kit (Shown above)	1	
6Y8-W0035-F1-00	6YC LCD Single Kit		
REMOTE CONTROL BOX AND SWITCH PANEL			
6X3-48206-02-00	6X3 Flush mount remote control	1	
64D-82570-22-00	Single Engine Key Switch	1	
10-PIN HARNESS			
688-8258A-50-00	5 m (16 ft)		
688-8258A-60-00	6 m (19 ft)		
688-8258A-70-00	7 m (23 ft)		
6K1-8258A-40-00	8 m (26 ft)	1	
61B-8258A-01-00	9.5 m (32 ft)		

For Y-COP, Multi-sensor and Gateway installations please see page 72-77

For Y-COP, Multi-sensor and Gateway installations please see page 72-77

MECHANICAL REMOTE CONTROL

SINGLE ENGINE (6Y8 GAUGES + 704 TOP MOUNT)

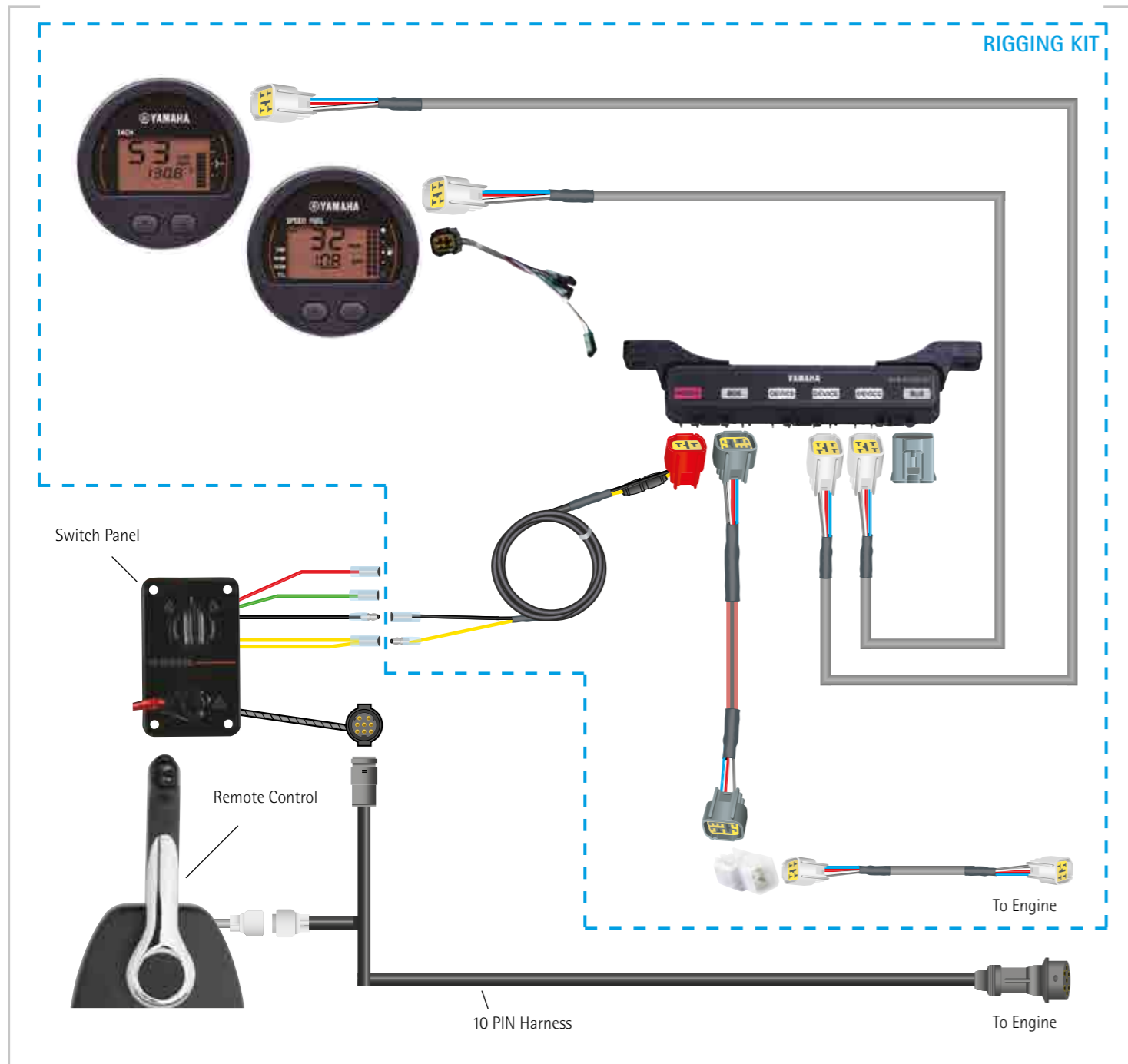

Part Number	Description	Qty	Price
RIGGING KIT			
6YR-W0035-Y3-00	6Y8 Round Tachometer Kit		
6Y8-W0035-E2-00	6Y8 Round Tacho + Speedo/FMM Kit (Shown above)	1	
6Y8-W0035-F1-00	6YC LCD Single Kit		
REMOTE CONTROL BOX AND SWITCH PANEL			
704-48205-P1-00	704 Top mount remote control	1	
704-82570-10-00	Single Engine Key Switch	1	
10-PIN HARNESS			
688-8258A-50-00	5 m (16 ft)		
688-8258A-60-00	6 m (19 ft)		
688-8258A-70-00	7 m (23 ft)	1	
6K1-8258A-40-00	8 m (26 ft)		
61B-8258A-01-00	9.5 m (32 ft)		

For Y-COP, Multi-sensor and Gateway installations please see page 72-77

TWIN ENGINE (6YC GAUGE)

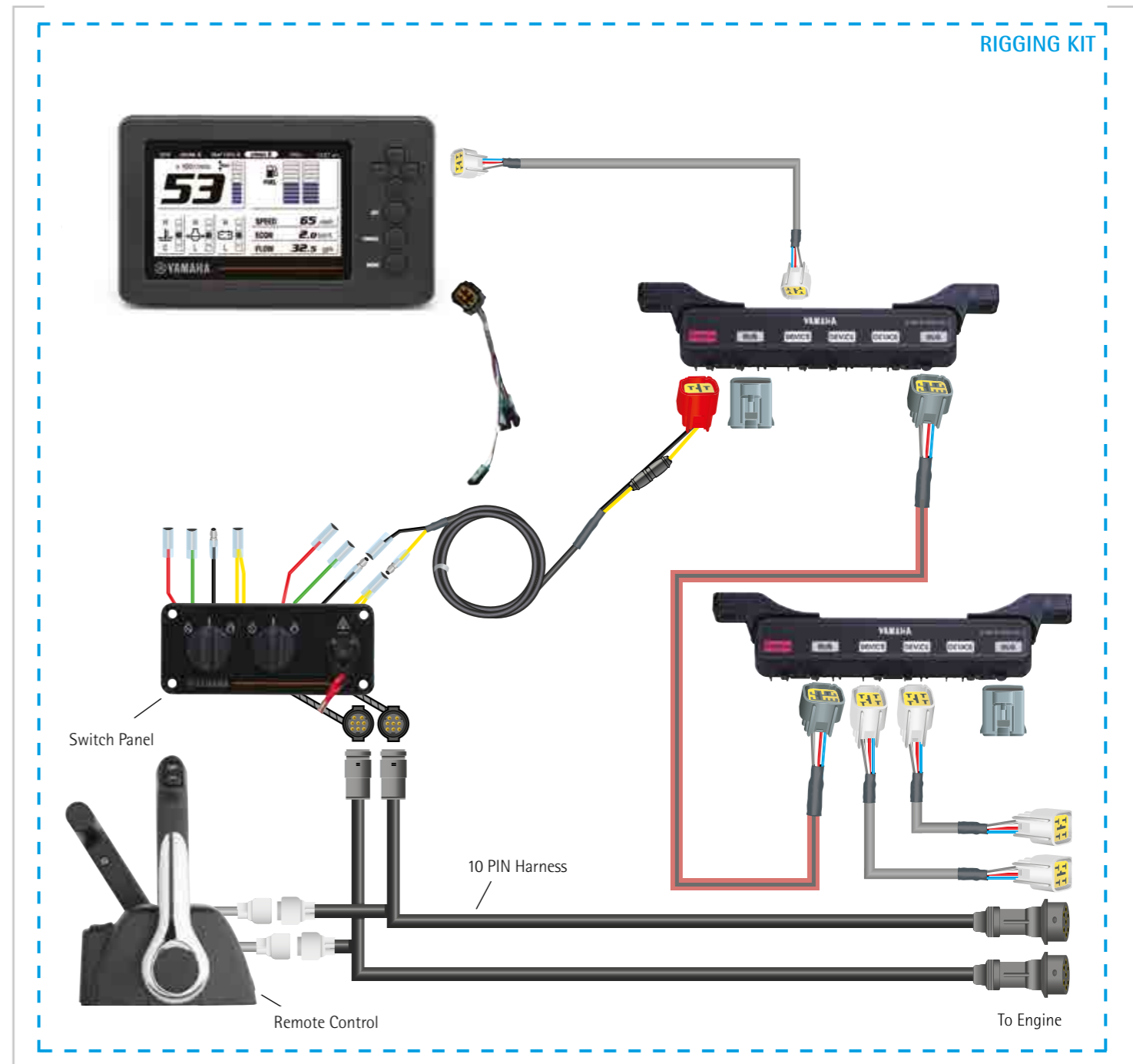

Part Number	Description	Qty	Price
RIGGING KIT			
6Y8-W0035-G2-00	6YC Counter Rotation Rigging Kit	1	

For Y-COP, Multi-sensor and Gateway installations please see page 72-77

DBW REMOTE CONTROL (MAIN STATION)

SINGLE ENGINE (6YC GAUGE + 6X7 FLUSH MOUNT)

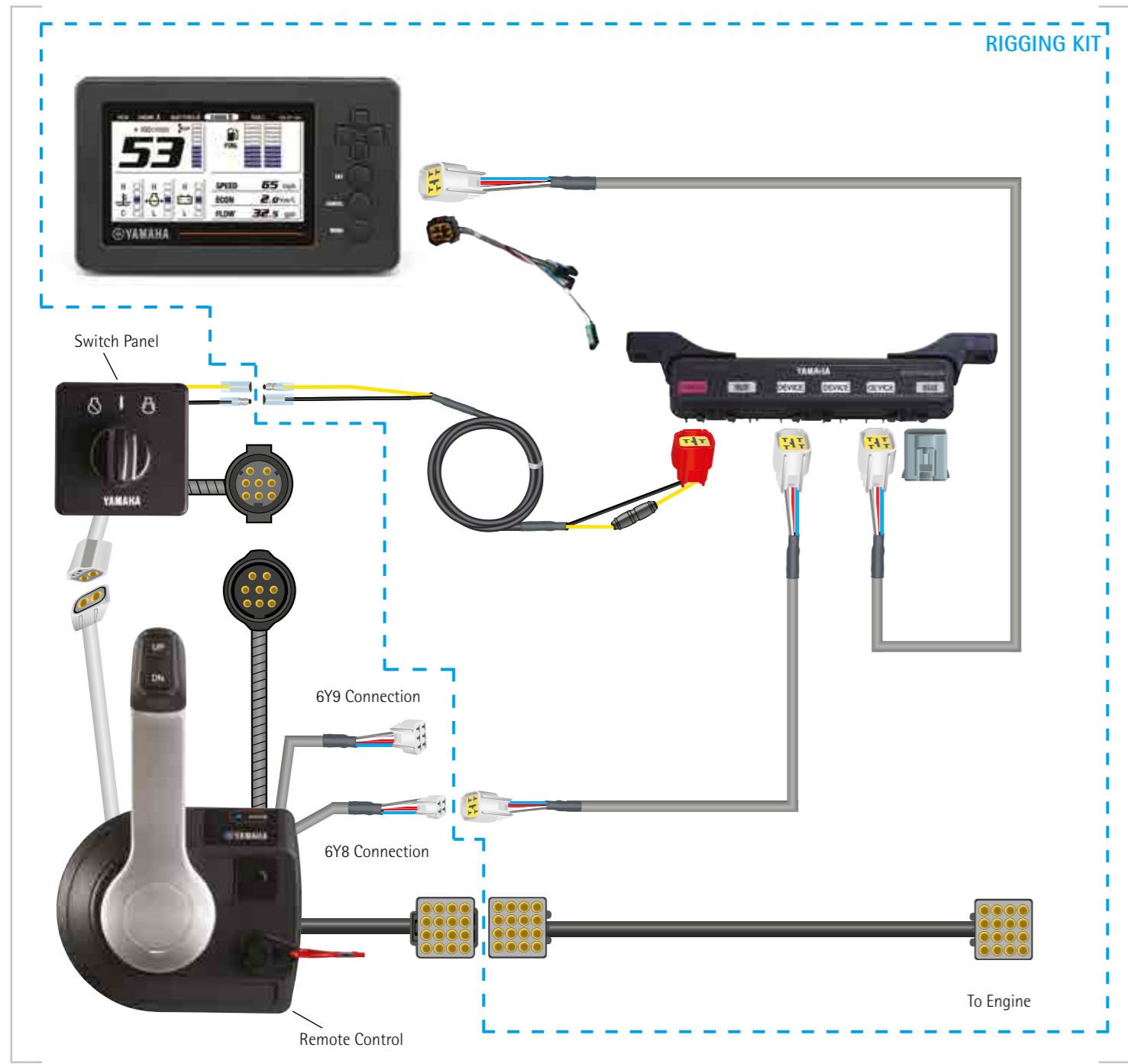

Part Number	Description	Qty	Price
RIGGING KIT			
6Y8-W0035-D2-00	6YC Single Rigging Kit	1	
REMOTE CONTROL BOX AND SWITCH PANEL			
6X7-48206-13-00	6X7 Flush mount remote control	1	
64D-82570-22-00	Single Engine Key Switch	1	

For Y-COP, Multi-sensor and Gateway installations please see page 72-77

SINGLE ENGINE (6Y9 COLOUR DISPLAY + 6X7 FLUSH MOUNT)

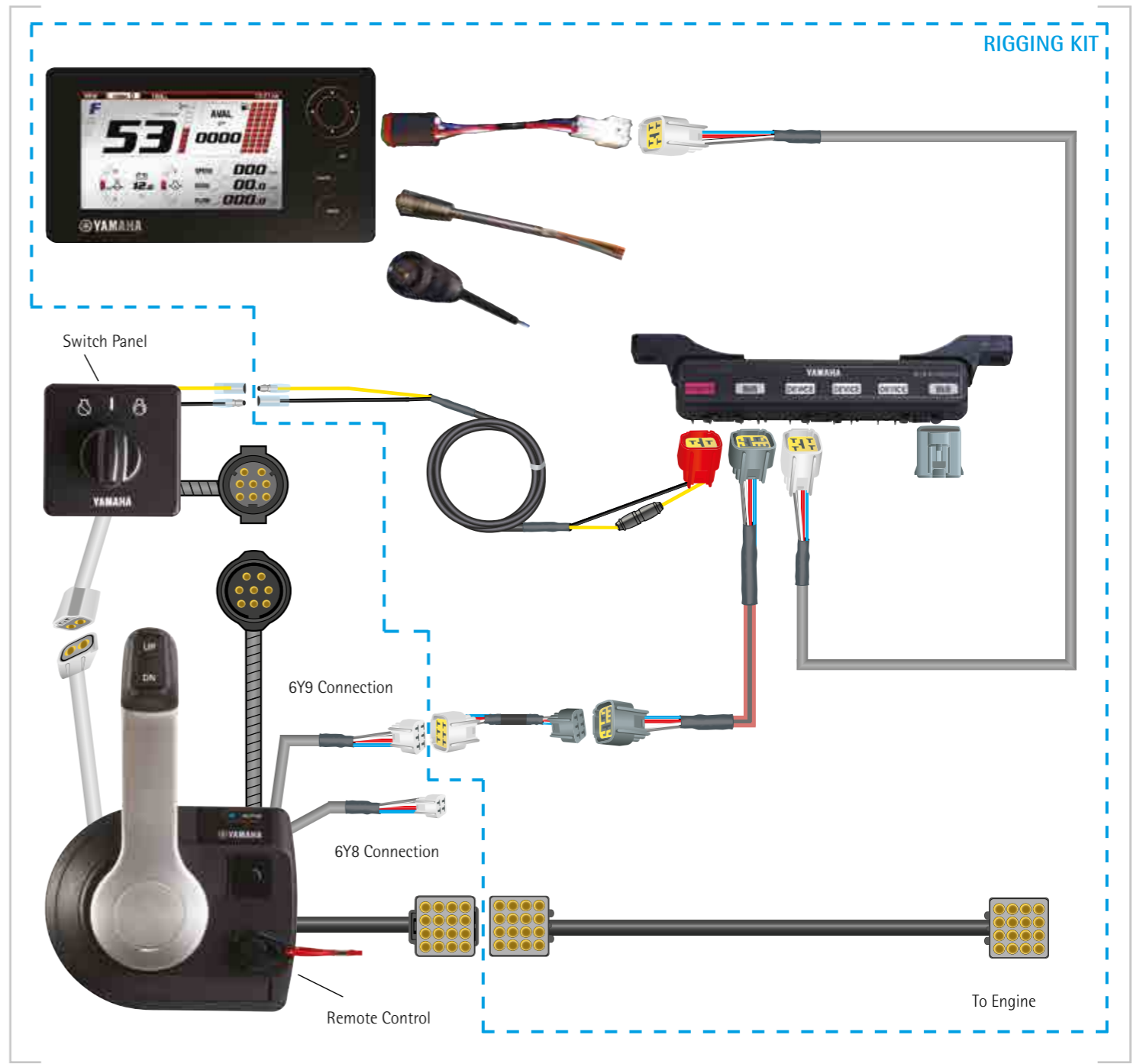

Part Number	Description	Qty	Price
RIGGING KIT			
6Y9-W0035-27-00	6Y9 Single Rigging Kit	1	
REMOTE CONTROL BOX AND SWITCH PANEL			
6X7-48206-13-00	6X7 Flush mount remote control	1	
64D-82570-22-00	Single Engine Key Switch	1	

For Y-COP, Multi-sensor and Gateway installations please see page 72-77

DBW REMOTE CONTROL (MAIN STATION)

SINGLE ENGINE (6Y8 GAUGES + 6X6 TOP MOUNT)

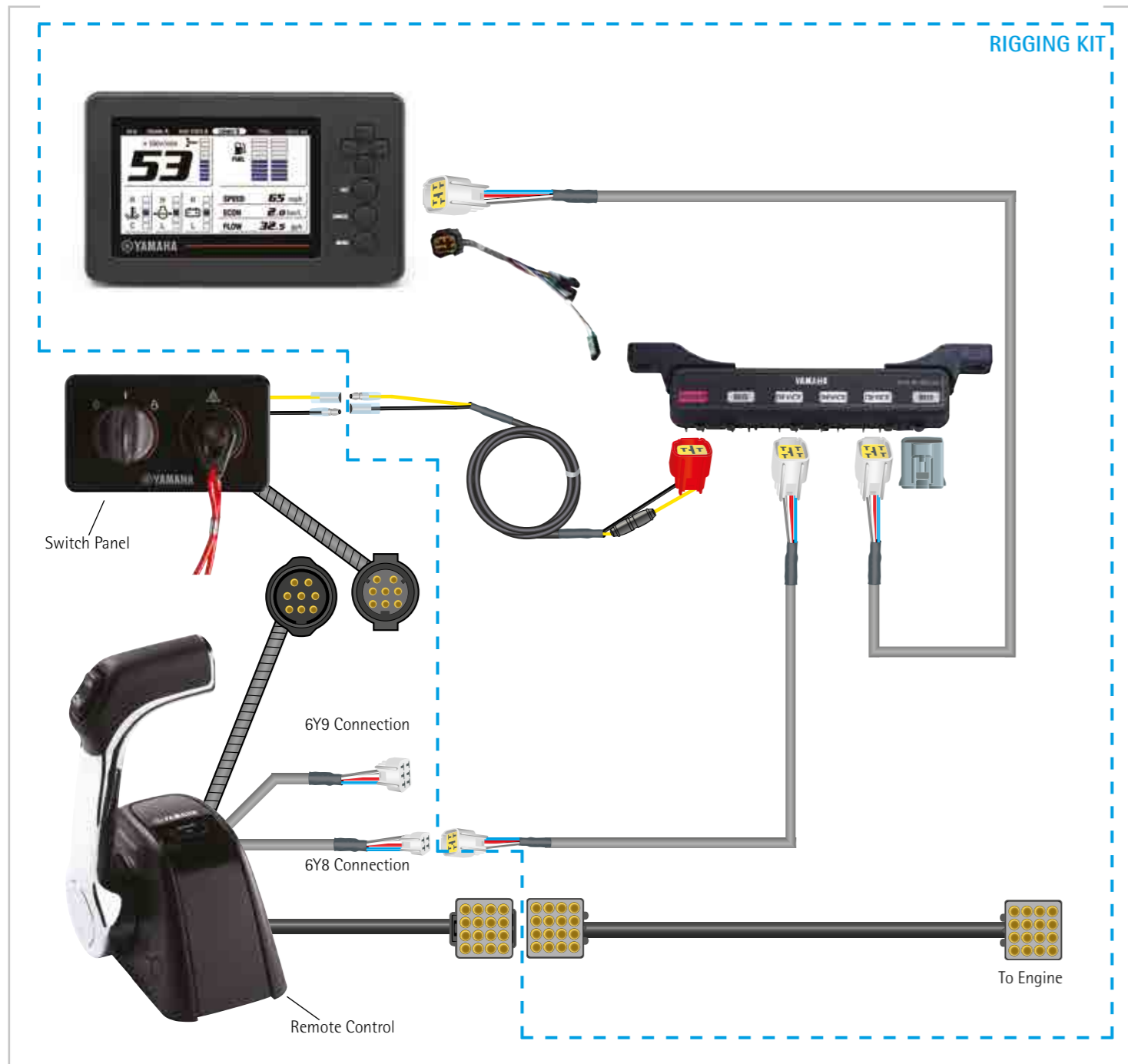

Part Number	Description	Qty	Price
RIGGING KIT			
6Y8-W0035-D2-00	6YC LCD Single Kit	1	
REMOTE CONTROL BOX AND SWITCH PANEL			
6X6-48205-36-00	6X6 Top mount remote control	1	
6X6-48205-46-00	6X6 Top mount remote control * For dual stations	1	
6X6-82570-31-00	Single Engine Key Switch	1	

For Y-COP, Multi-sensor and Gateway installations please see page 72-77

SINGLE ENGINE (6Y9 COLOUR DISPLAY + 6X6 TOP MOUNT)

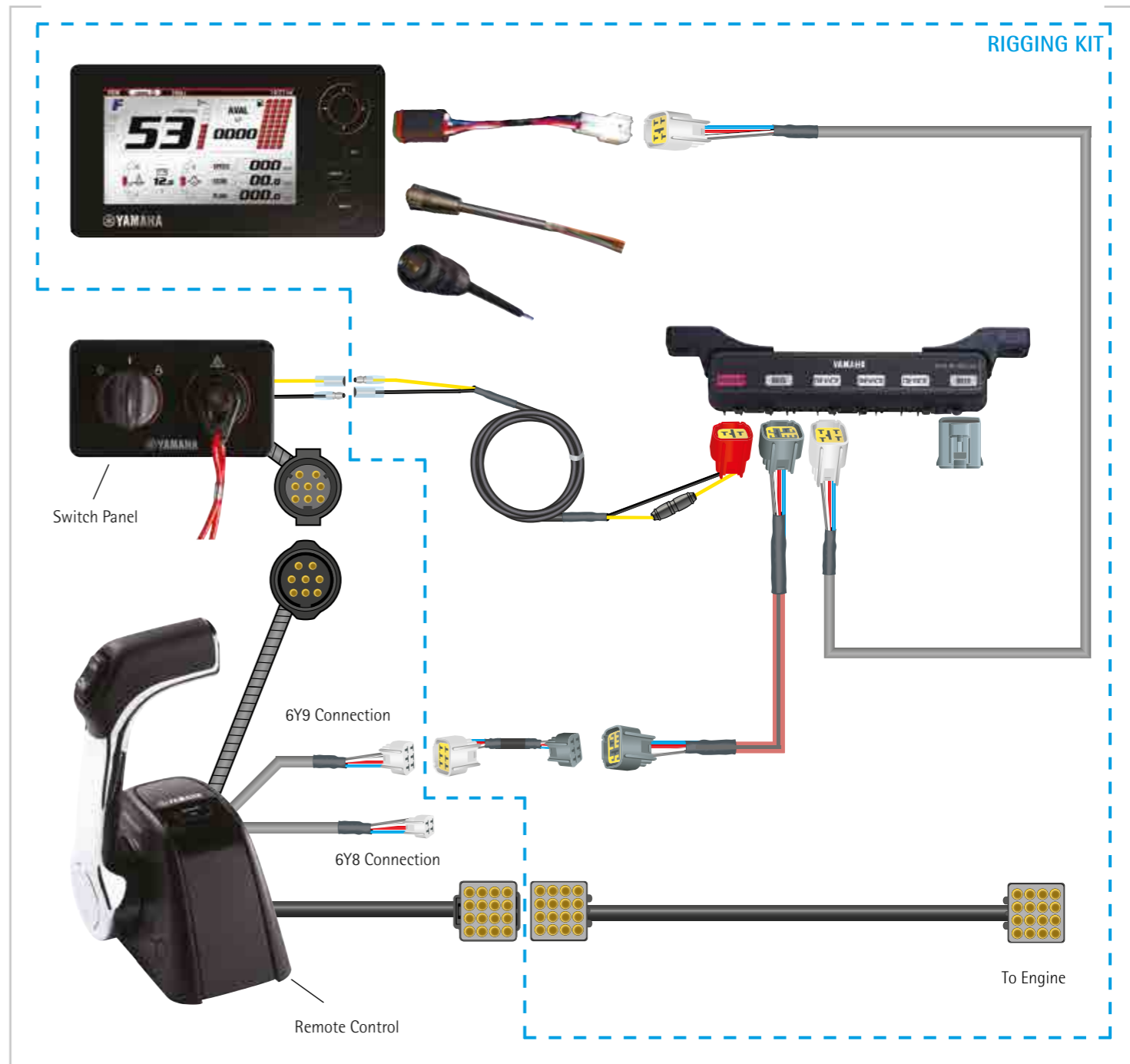

Part Number	Description	Qty	Price
RIGGING KIT			
6Y9-W0035-27-00	6Y9 Single Rigging Kit	1	
REMOTE CONTROL BOX AND SWITCH PANEL			
6X6-48205-36-00	6X6 Top mount remote control	1	
6X6-48205-46-00	6X6 Top mount remote control * For dual stations	1	
6X6-82570-32-00	Single Engine Key Switch	1	

For Y-COP, Multi-sensor and Gateway installations please see page 72-77

DBW REMOTE CONTROL (MAIN STATION)

TWIN ENGINE (6YC GAUGE)

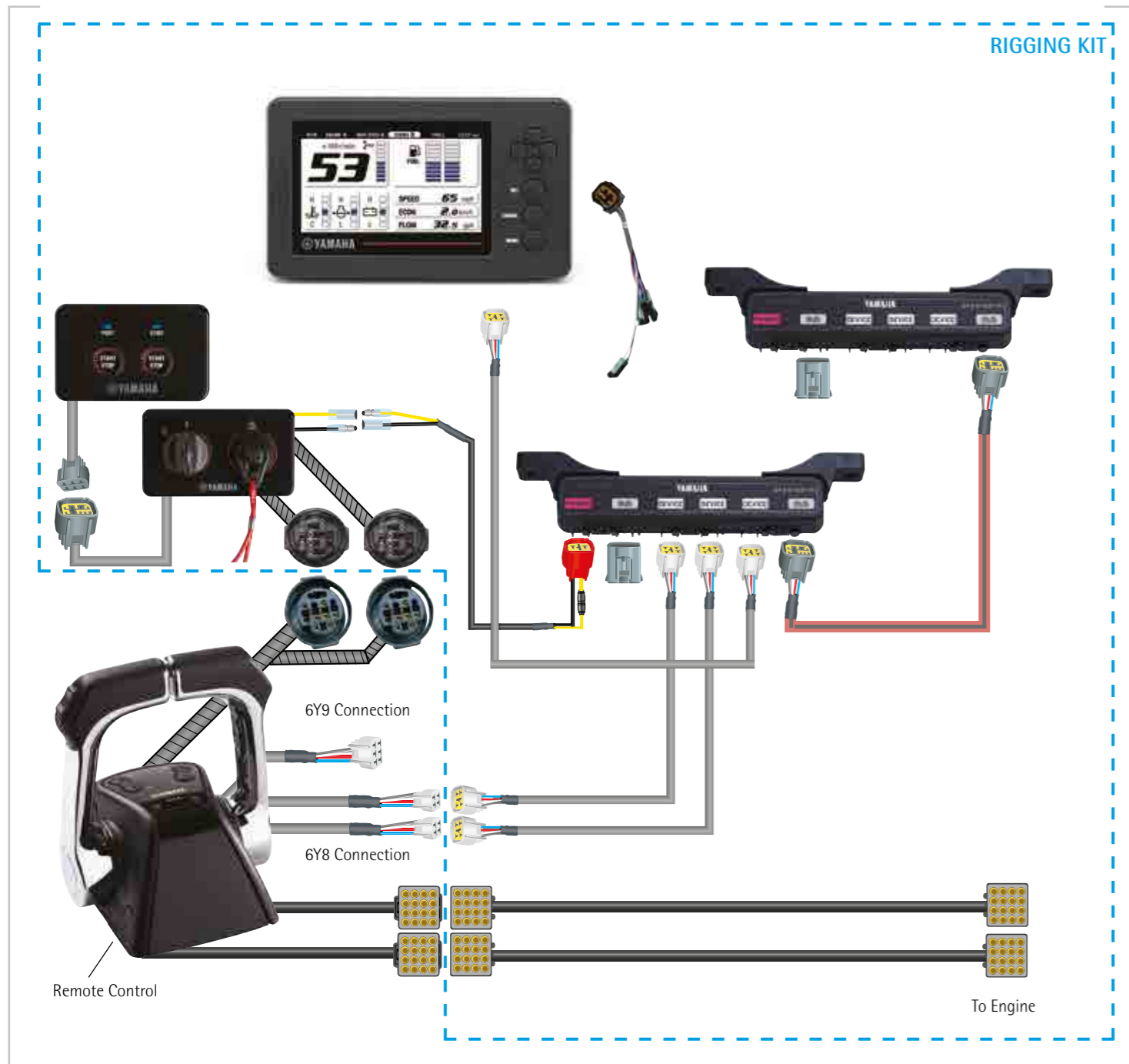

Part Number	Description	Qty	Price
RIGGING KIT			
6Y8-W0035-B2-00	6YC Twin Rigging Kit	1	
REMOTE CONTROL BOX			
6X6-48207-36-00	6X6 Twin Engines Top mount control	1	
6X6-48207-46-00	6X6 Twin Engines Top mount control * For dual stations		

For Y-COP, Multi-sensor and Gateway installations please see page 72-77

TWIN ENGINE (6Y9 COLOUR DISPLAY)

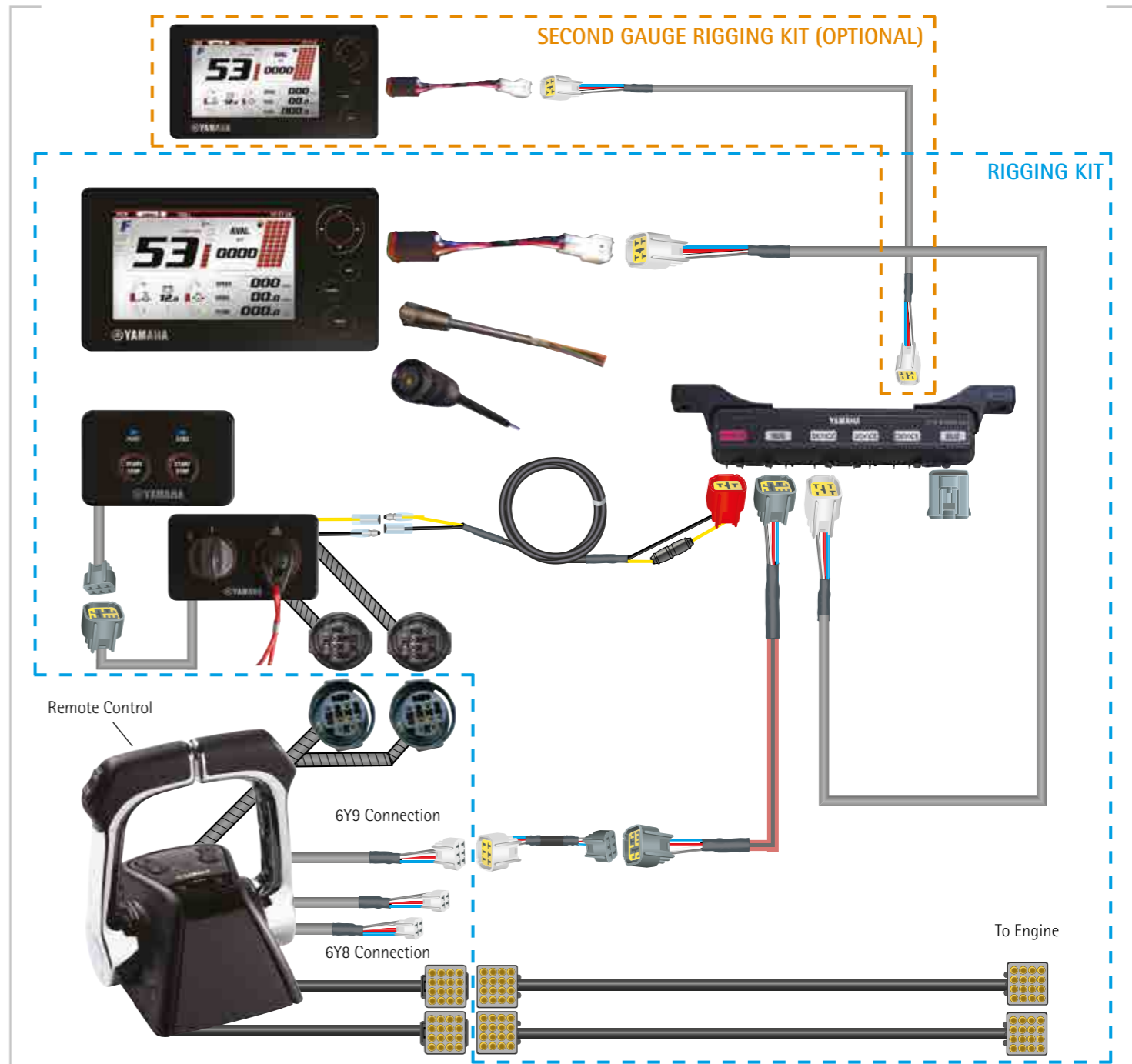

Part Number	Description	Qty	Price
RIGGING KIT			
6Y9-W0035-18-00	6Y9 Twin Rigging Kit	1	
6Y9-W0035-36-00	6Y9 Second Gauge Kit (optional)	1	
REMOTE CONTROL BOX			
6X6-48207-36-00	6X6 Twin Engines Top mount control	1	
6X6-48207-46-00	6X6 Twin Engines Top mount control * For dual stations		

For Y-COP, Multi-sensor and Gateway installations please see page 72-77

DBW REMOTE CONTROL (MAIN STATION)

TRIPLE ENGINE (6Y9 COLOUR DISPLAY)

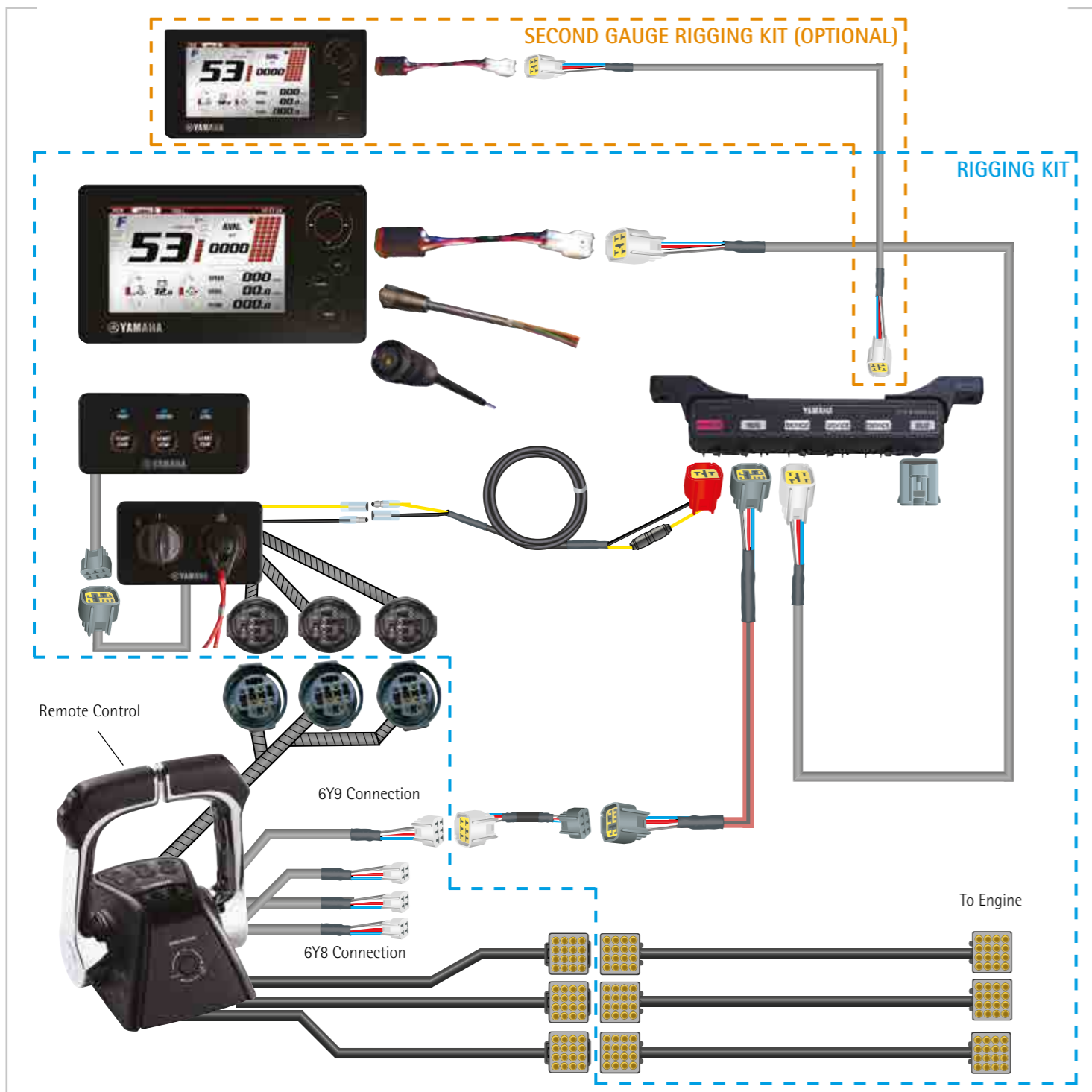

Part Number	Description	Qty	Price
DBW RIGGING KIT			
6Y9-W0035-46-00	6Y9 Triple Rigging Kit	1	
6Y9-W0035-36-00	6Y9 Second Gauge Kit (optional)	1	
REMOTE CONTROL BOX			
6X6-48208-46-00	6X6 Triple Engines Top mount control (supporting both single/dual station)	1	

DBW REMOTE CONTROL (2ND STATION)

SINGLE ENGINE

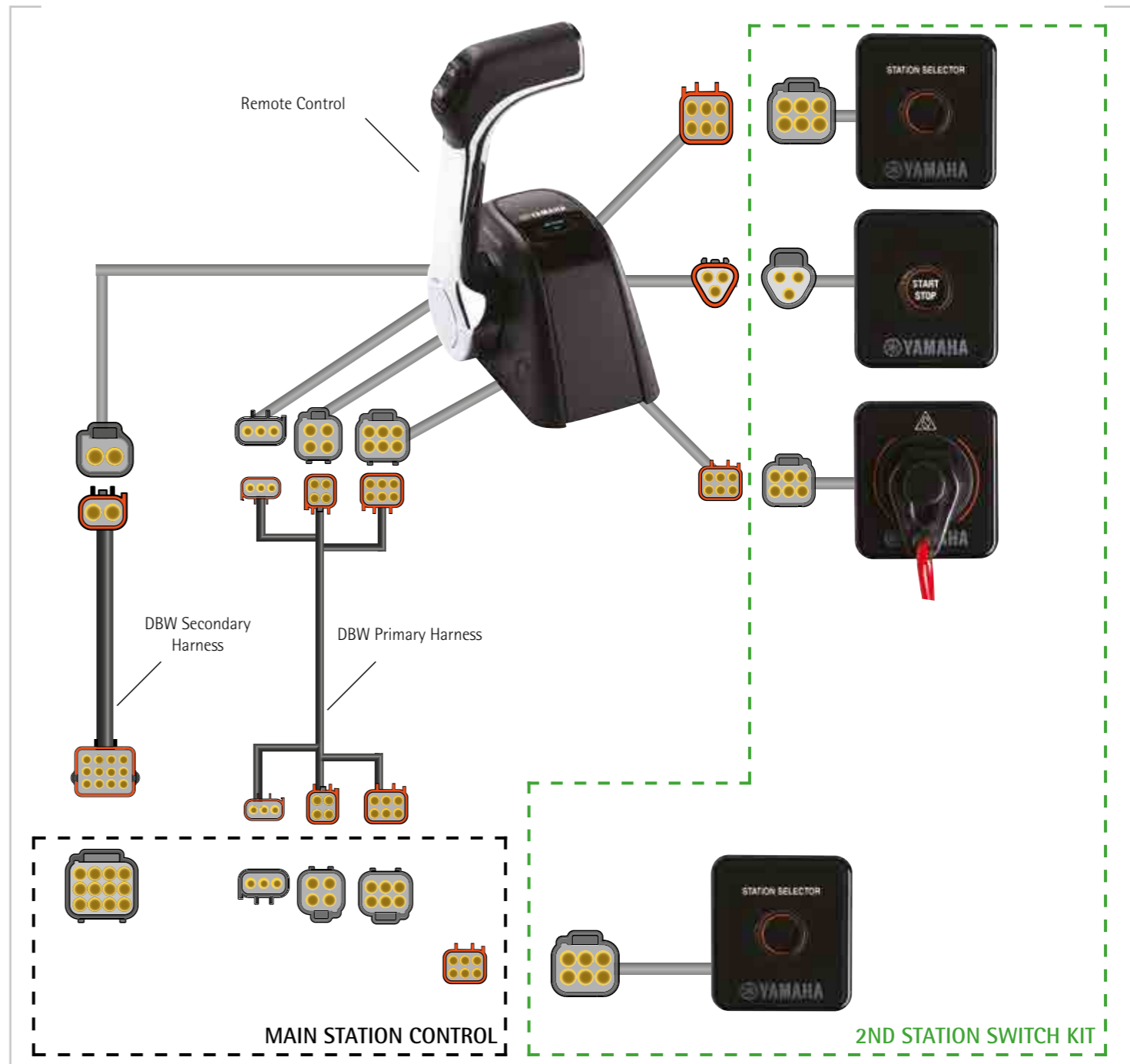

Part Number	Length/Description	Qty	Price
DBW PRIMARY HARNESS (3-4-6 PIN)			
6X6-8258A-G1-00	5 m (16 ft)		
6X6-8258A-H1-00	8 m (26 ft)	1	
6X6-8258A-J1-00	12 m (38 ft)		
DBW SECONDARY HARNESS (2-12 PIN)			
6X6-8258A-B1-00	5 m (16 ft)		
6X6-8258A-D1-00	8 m (26 ft)	1	
6X6-8258A-F1-00	12 m (38 ft)		
REMOTE CONTROL BOX AND SWITCH PANEL			
6X6-48205-55-00	6X6 Top mount remote control * For sub (2nd) station	1	
6X6-W0035-70-00	Single Engine Second Station Switch Kit	1	

For Y-COP, Multi-sensor and Gateway installations please see page 72-77

For Y-COP, Multi-sensor and Gateway installations please see page 72-77

DBW REMOTE CONTROL (2ND STATION)

TWIN ENGINE

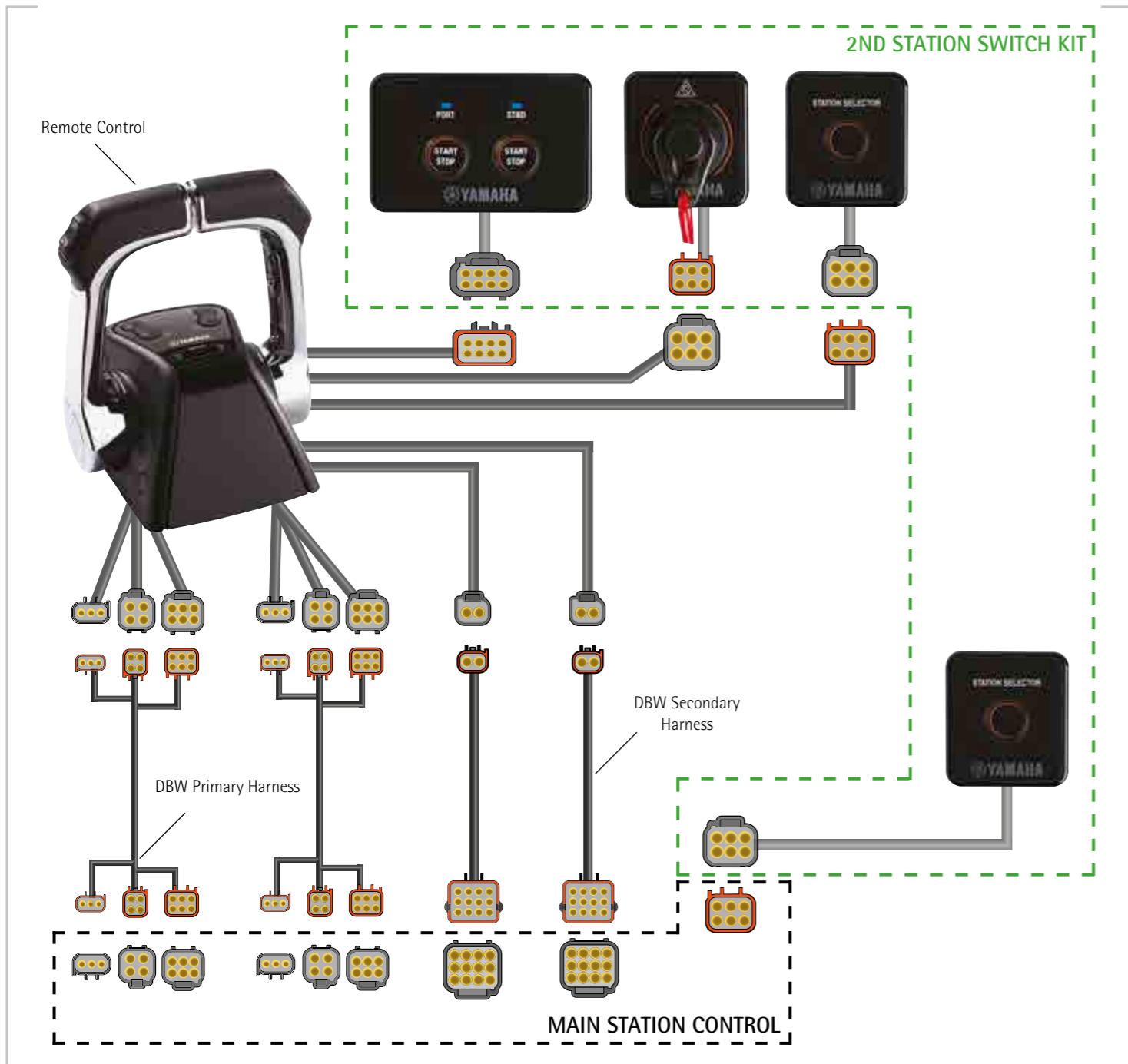

Part Number	Length/Description	Qty	Price
DBW PRIMARY HARNESS (3-4-6 PIN)			
6X6-8258A-G1-00	5 m (16 ft)		
6X6-8258A-H1-00	8 m (26 ft)	2	
6X6-8258A-J1-00	12 m (38 ft)		
DBW SECONDARY HARNESS (2-12 PIN)			
6X6-8258A-B1-00	5 m (16 ft)		
6X6-8258A-D1-00	8 m (26 ft)	2	
6X6-8258A-F1-00	12 m (38 ft)		
REMOTE CONTROL BOX AND SWITCH PANEL			
6X6-48207-54-00	6X6 Twin Engine Top mount control * For sub (2nd) station	1	
6X6-W0035-80-00	Twin Engines 2nd Station Switch Kit	1	

For Y-COP, Multi-sensor and Gateway installations please see page 72-77

TRIPLE ENGINE

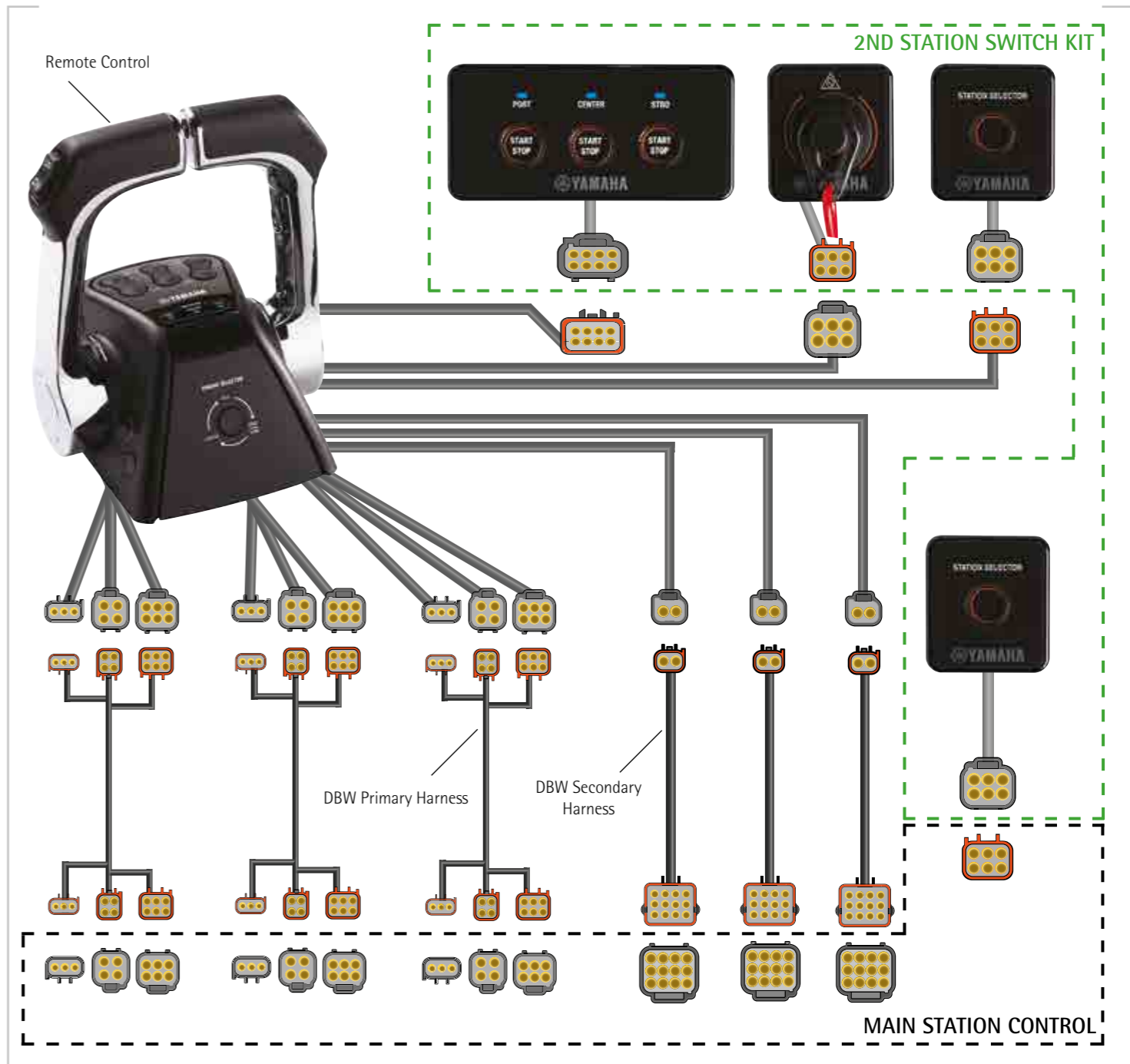

Part Number	Length/Description	Qty	Price
DBW PRIMARY HARNESS (3-4-6 PIN)			
6X6-8258A-G1-00	5 m (16 ft)		
6X6-8258A-H1-00	8 m (26 ft)	3	
6X6-8258A-J1-00	12 m (38 ft)		
DBW SECONDARY HARNESS (2-12 PIN)			
6X6-8258A-B1-00	5 m (16 ft)		
6X6-8258A-D1-00	8 m (26 ft)	3	
6X6-8258A-F1-00	12 m (38 ft)		
REMOTE CONTROL BOX AND SWITCH PANEL			
6X6-48208-53-00	6X6 Triple Engine Top mount control * For sub (2nd) station	1	
6X6-W0035-90-00	Triple Engines 2nd Station Switch Kit	1	

For Y-COP, Multi-sensor and Gateway installations please see page 72-77

MULTI-SENSOR

FOR 6Y9 COLOUR DISPLAY

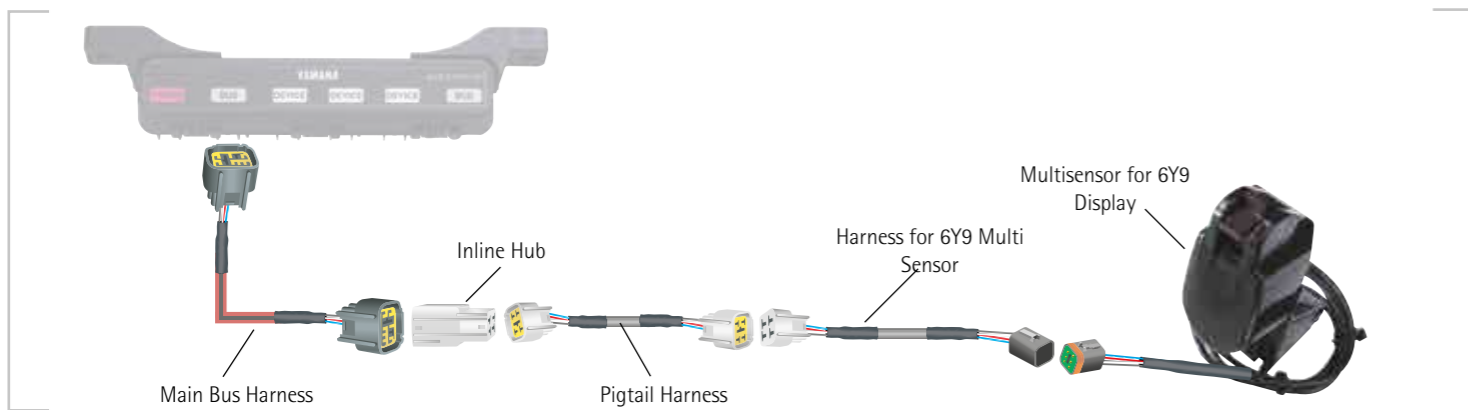

MULTI-SENSOR, HUB AND CONVERSION HARNESSSES

PART NUMBER	DESCRIPTION	QTY	PRICE
6Y9-83688-00-00	Multisensor for 6Y9 Display	1	
6Y8-83688-01-00	Multisensor for 6Y8 Gauge	1	
6Y8-81920-11-00	Inline Hub	1	
6Y9-83553-60-00	Harness for 6Y9 Multi Sensor	1	

MAIN BUS HARNESS (6-PIN)

PART NUMBER	LENGTH	PRICE
6Y8-82553-41-00	9.1 m (30 ft)	
6Y8-82553-31-00	7.6 m (25 ft)	
6Y8-82553-21-00	6.1 m (20 ft)	
6Y8-82553-11-00	4.6 m (15 ft)	
6Y8-82553-50-00	3.0 m (10 ft)	
6Y8-82553-01-00	0.3 m (1 ft)	

PIGTAIL BUS HARNESS (4-PIN)

PART NUMBER	LENGTH	PRICE
6Y8-82521-51-00	3.6 m (12 ft)	
6Y8-82521-41-00	2.7 m (9 ft)	
6Y8-82521-31-00	1.8 m (6 ft)	
6Y8-82521-21-00	0.9 m (3 ft)	
6Y8-82521-11-00	0.6 m (2 ft)	
6Y8-82521-01-00	0.3 m (1 ft)	

DBW MAIN BUS ADAPTOR HARNESS

PART NUMBER	QTY	PRICE
6Y9-82553-00-00		

GATEWAY/AGI

GATEWAY

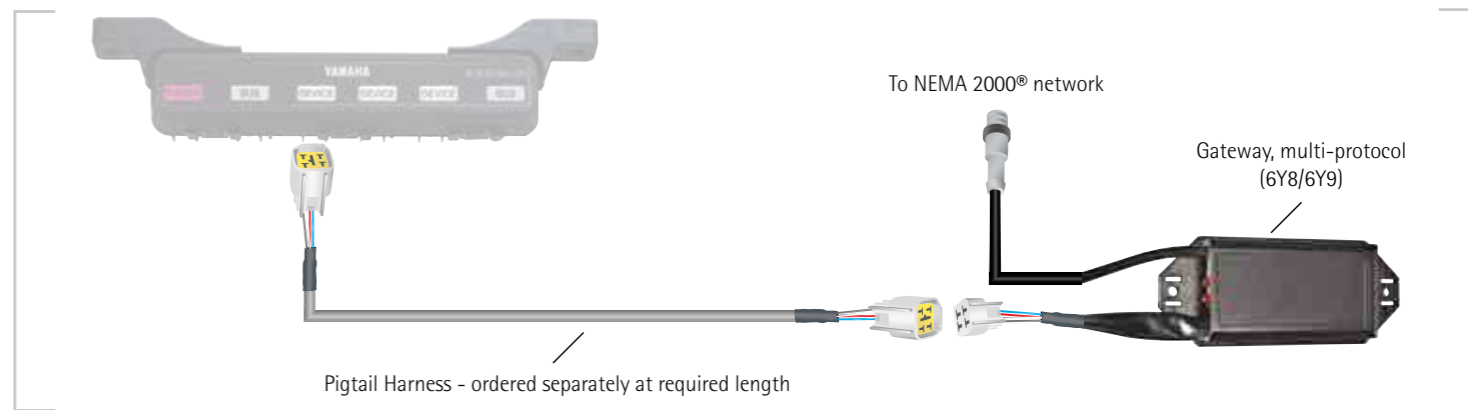

AGI

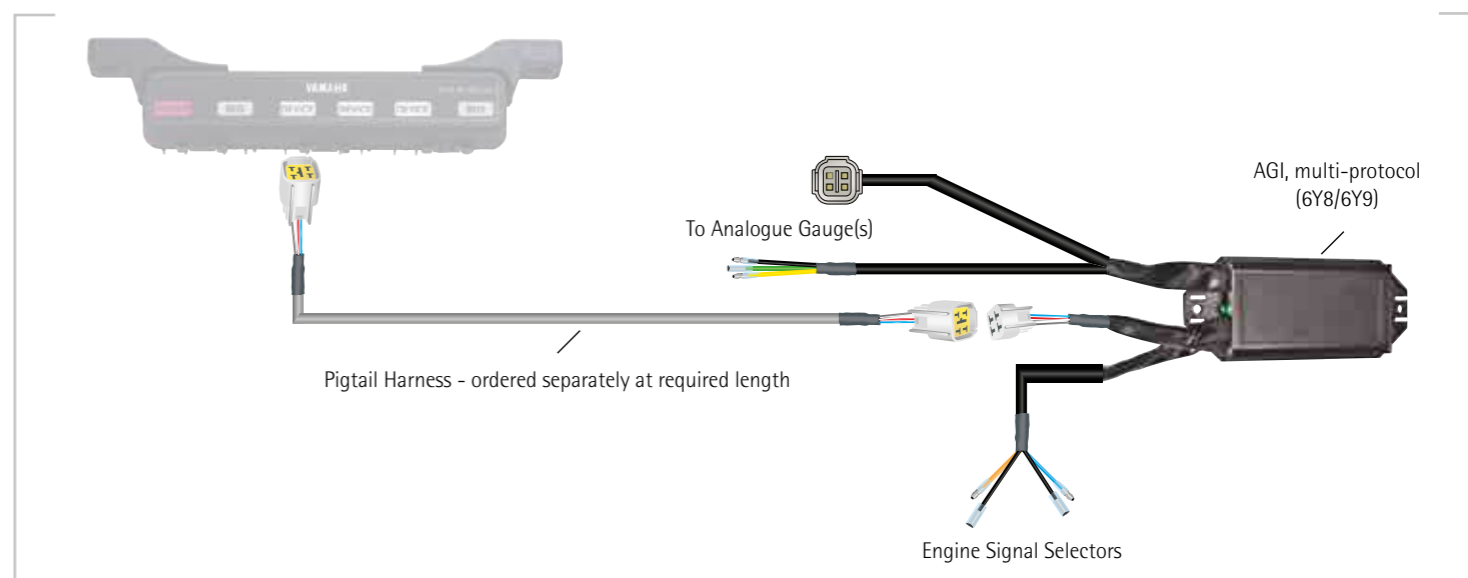

GATEWAY AND ANALOGUE GAUGE INTERFACE

PART NUMBER	DESCRIPTION	QTY	PRICE
6Y9-8A2D0-20-00	Gateway, multi-protocol (6Y8/6Y9)	1	
6Y9-8A2D0-30-00	AGI, multi-protocol (6Y8/6Y9)	1	



Y-COP WITH 6X4 MULTI-FUNCTION TILLER HANDLE

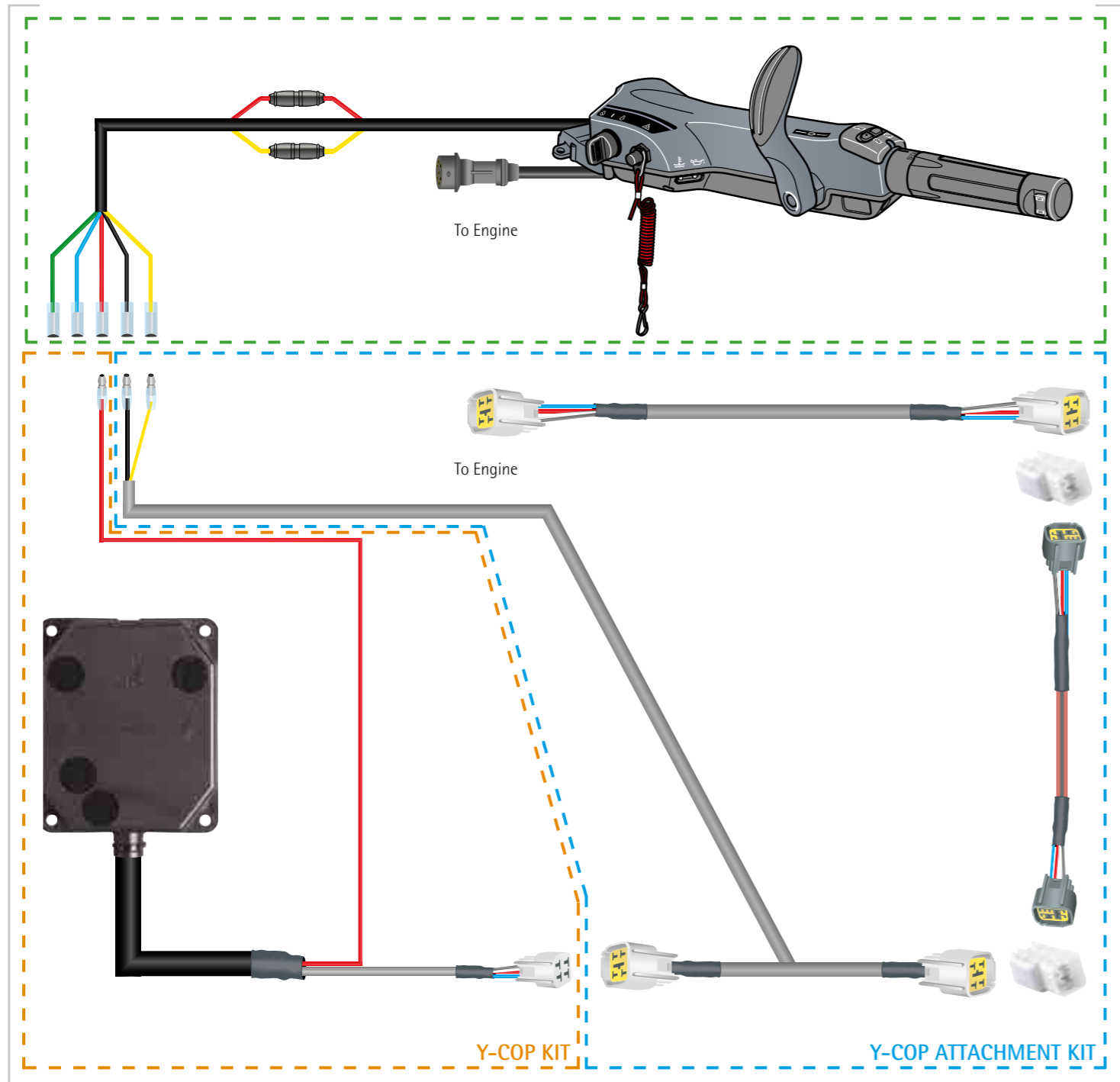

Part Number	Description	Qty	Price
Y-COP			
6Y8-W0035-J0-00	Y-COP Kit	1	
Y-COP ATTACHMENT KIT			
6Y8-W0035-C0-00	Y-COP Attachment Kit (required for Y-COP + 6X4 handle installation)	1	
ENGINE GROMMET FOR Y-COP HARNESS*			
6C5-42725-50-00	F50H/FT50J/F50F/FT60G	1	
68V-42725-20-00	F80B/F100D/F115A	1	

*Required for Y-COP + 6X4 Tiller Handle installations on the specific engine models listed above.

Y-COP WITH SINGLE ENGINE

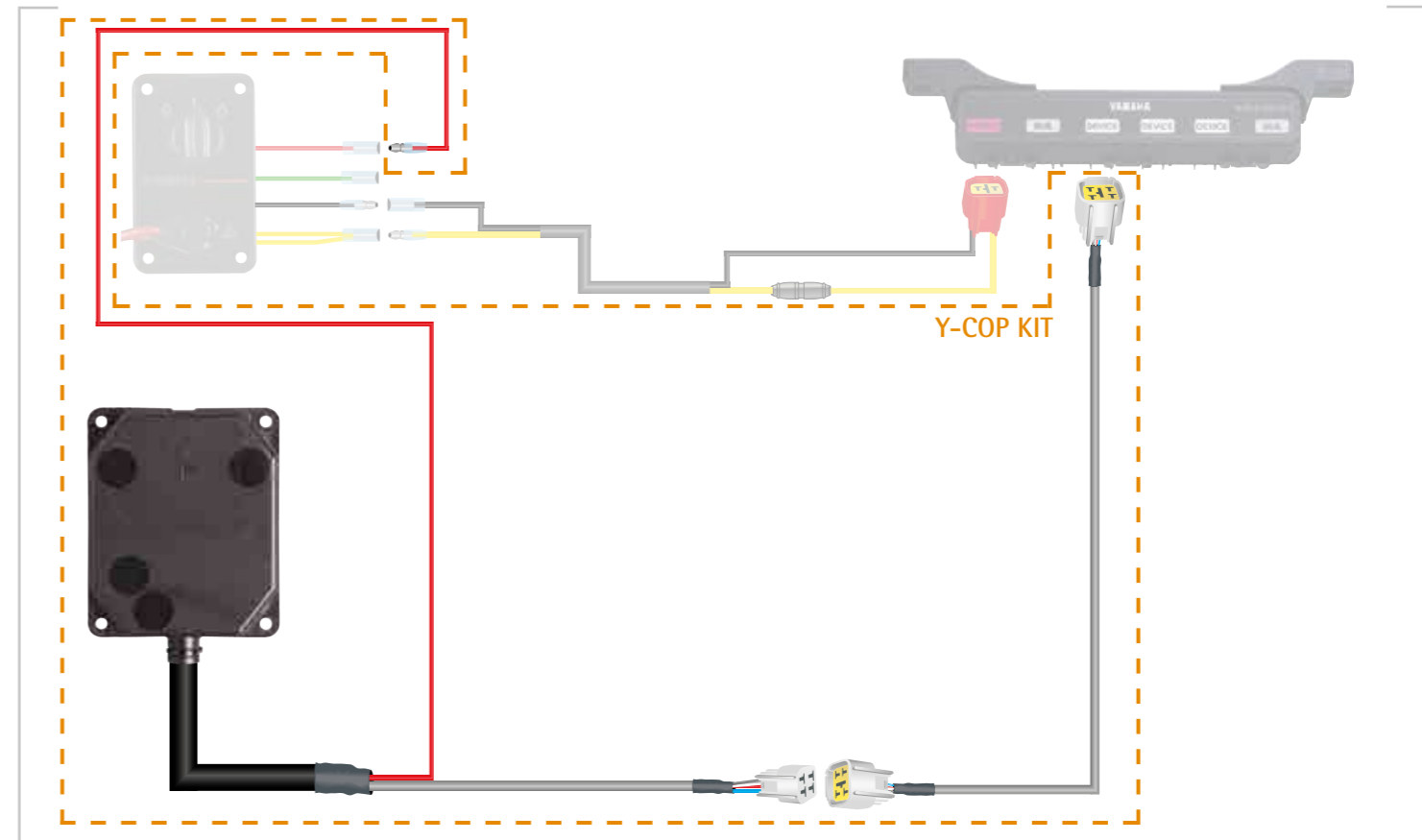

Part Number	Description	Qty	Price
Y-COP			
6Y8-W0035-J0-00	Y-COP Kit	1	

Y-COP WITH MULTIPLE ENGINES (MECHANICAL REMOTE CONTROL)

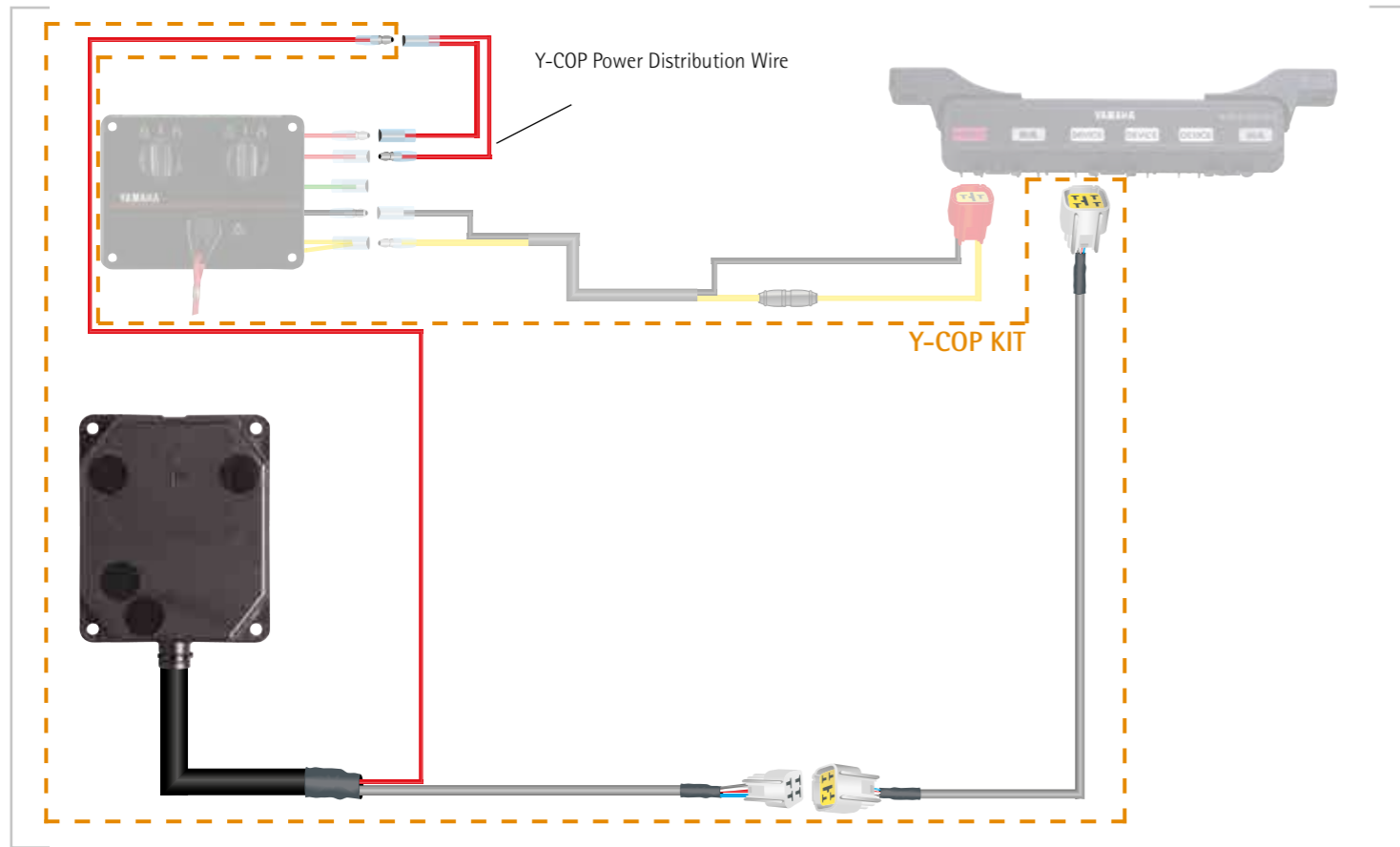

Part Number	Description	Qty	Price
Y-COP			
6Y8-W0035-J0-00	Y-COP Kit	1	
6H5-81315-00-00	Y-COP Power Distribution Wire (for multiple engines / Mechanical control)	1	

Y-COP WITH MULTIPLE ENGINES (DBW REMOTE CONTROL)

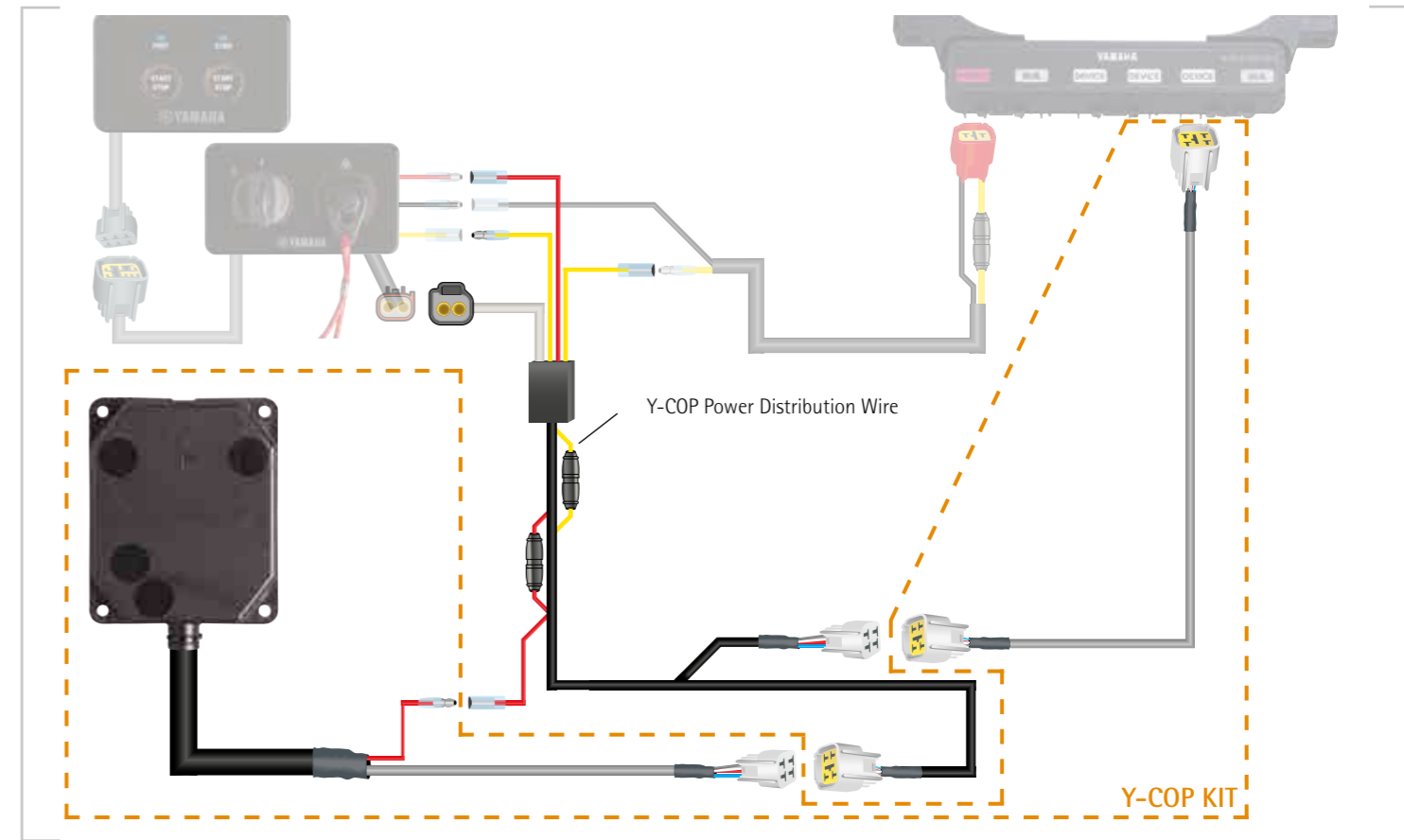

Part Number	Description	Qty	Price
Y-COP			
6Y8-W0035-J0-00	Y-COP Kit	1	
6Y8-81315-00-00	Y-COP Power Distribution Wire (for multiple engines / DBW control)	1	

Yamalube® lubricants and Careline marine products

FOR THE SMOOTH, LONG TERM RELIABILITY OF YOUR YAMAHA, THERE'S SIMPLY NOTHING BETTER!

Yamalube® marine lubricants are specifically formulated for Yamaha outboard engines and personal watercraft - and tested to levels they would never normally experience in the hands of an owner. The result is a smoother, more confident ride every time you hit the water.

QUALITY PROTECTION FOR EXTREME CONDITIONS

Yamalube® is designed to work at its best under pressure - the sort it will face every day in Yamaha's mighty 5.3 litre, 32-valve V8 outboard, the F350.

HELPING ENGINES TO LIVE LONGER

By minimizing engineering enemies like spark-plug fouling, ring-sticking and pre-ignition, Yamalube® oil protects engines better - for longer.

KEEPING YOUR ENGINE CLEANER

The powerful, efficient action of the anti-oxidants in Yamalube® marine lubricants keep engine components clean and prevent the formation of sludge.

ANTI-CORROSION AND ANTI-RUST

Special features fight corrosion and rust, ensuring maximum protection of the engine's internal components against the hazards of the marine environment.

FORMULATED TO NMMA STANDARDS

To be certified by the NMMA (National Marine Manufacturers Association) engine oils must meet their stringent standards for viscosity, corrosion, filter-plugging, foaming and aeration.



YAMALUBE® 4-S FULLY SYNTHETIC MARINE OIL

A unique, top-performance marine formula oil, specially developed for high horsepower outboard engines - with the focus on providing improved fuel economy.

FEATURES & BENEFITS

Unique marine formula, compatible with engines with catalytic converters or exhaust gas treatment devices

Provides excellent fuel economy - better than the majority of engine oils in the market

Advanced anti-wear protection for the engine components

Powerful anti-oxidant action to protect engine parts and keep them clean

Unique corrosion inhibitor protects the vital engine parts against the marine environment - both when running and at idle

Keeps the engine ultra-clean and preserves its power

To give your customer the best possible advice, please see the Yamalube® application charts on pages 90-92.



SPECIFICATIONS

STANDARDS: Approved as FC-W Catalyst Compatible™, a New FC-W Specification, Issued in 2009 by NMMA (National Marine Manufacturers Association) - the only approved 5W30 oil available in the market.

Oil GRADE	SAE	5W-30
Colour	Visual	Brown
Density at 15°C (59°F)	ASTM D1298	0.853 g/cm ³
Kinematic viscosity at 100°C (212°F)	ASTM D445	11.20 mm ² /s
Viscosity index	ASTM D2270	259
Flash point	ASTM D92	225°C
Pour point	ASTM D97	-45°C
Total Base Number	ASTM D2896	7.50 mg KOH/g





YAMALUBE® 4-S SUPER SYNTHETIC MARINE OIL

Very high performance motor oil specially developed for 4-stroke outboard motors.

FEATURES & BENEFITS

- Approved in rust test and corrosion standard, as specified by the NMMA
 - Improved fuel economy
 - Advanced anti-wear protection
 - Powerful anti-oxidant action to protect engine parts and keep them clean
 - Unique corrosion inhibitor protects the vital engine parts against the marine environment - both when running and at idle
 - Good detergency & dispersancy to clean the engine and preserve its power
 - Excellent shear stability to ensure good lubrication under all conditions
- To give your customer the best possible advice, please see the Yamalube® application charts on pages 90-92.



SPECIFICATIONS

STANDARDS: Officially approved as FC-WTM by NMMA (National Marine Manufacturers Association)

Oil GRADE	SAE	10W-30
Colour	Visual	Brown
Density at 15°C (59°F)	ASTM D1298	0.879 g/cm3
Kinematic viscosity at 100°C (212°F)	ASTM D445	10.8 mm2/s
Viscosity index	ASTM D2270	145
Flash point	ASTM D92	225°C
Pour point	ASTM D97	-37.5°C
Total Base Number	ASTM D2896	6.88 mg KOH/g
Sulphated ash	ASTM D874	0.76 mass %

YAMALUBE® 4-S SYNTHETIC MARINE OIL

This high-performance motor oil, has been developed for 4-stroke outboard motors and 4-stroke Yamaha personal watercraft.

FEATURES & BENEFITS

- Good anti-wear protection
 - Powerful anti-oxidant action to protect engine parts and keep them clean
 - Long lasting protection against engine stress, resulting in smooth operation of the engine
 - Improved detergency and dispersancy to keep the engine clean and preserve its power & fuel efficiency
 - Good anti-corrosion and anti-foaming properties
- To give your customer the best possible advice, please see the Yamalube® application charts on pages 90-92.



SPECIFICATIONS

STANDARDS: Exceeds API SJ standards

Oil GRADE	SAE	10W-30	10W-40
Colour	Visual	Brown	Brown
Density at 15°C (59°F)	ASTM D1298	0.880 g/cm3	0.879 g/cm3
Kinematic viscosity at 100°C (212°F)	ASTM D445	10.8 mm2/s	13.4 mm2/s
Viscosity index	ASTM D2270	147	155
Flash point	ASTM D92	224°C	220°C
Pour point	ASTM D97	-40°C	-40°C
Total Base Number	ASTM D2896	7.64 mg KOH/g	7.61 mg KOH/g
Foam sequence II	ASTM D892	20/0 ml max.	20/0 ml max.
Sulphated ash	ASTM D874	1.0 mass %	1.02 mass %

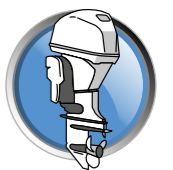



YAMALUBE® 2-W ENGINE OIL

A premium semi-synthetic oil, specially developed, tested and approved by Yamaha for 2-stroke Yamaha personal watercraft engines

FEATURES & BENEFITS

- Low ash minimizes plug fouling and pre-ignition
- Detergent/dispersant formulation to minimise deposits on pistons and cylinder rings
- Good lubricity and anti-scuffing protection for smooth engine operation
- Good anti-corrosion and anti-rust capability
- Reduces production of exhaust smoke

To give your customer the best possible advice, please see the Yamalube® application charts on pages 90-92.



SPECIFICATIONS		
Colour	Visual	Purple
Density at 15°C (59°F)	ASTM D1298	0.8628 g/cm3
Kinematic viscosity at 100°C (212°F)	ASTM D445	6.74 mm2/s
Viscosity index	ASTM D2270	136
Flash point	ASTM D92	96°C
Pour point	ASTM D97	-42°C
Total Base Number	ASTM D2896	1.6 mg KOH/g



YAMALUBE® 2-M SUPER ENGINE OIL

High quality special formulation for 2-stroke marine engines. Developed, tested and approved by Yamaha.

FEATURES & BENEFITS

- High quality anti-wear formula to protect against piston binding
 - Enhances the cleanliness of engine components - particularly the piston and exhaust port - and prevents sludge formation
 - Outstanding anti-corrosion and anti-rust capability to provide protection for the engine components
 - Lowers exhaust smoke by burning without leaving sticky deposits
 - Reduces ring-sticking, spark plug fouling and pre-ignition
 - Withstands the high temperatures and pressures found in modern engines - low aquatic toxicity
- To give your customer the best possible advice, please see the Yamalube® application charts on pages 90-92.



SPECIFICATIONS		
Colour	Visual	Dark Green
Density at 15°C (59°F)	ASTM D1298	0.8714 g/cm3
Kinematic viscosity at 100°C (212°F)	ASTM D445	6.807 mm2/s
Viscosity index	ASTM D2270	145
Flash point	ASTM D92	88°C
Pour point	ASTM D97	-45°C
Total Base Number	ASTM D2896	10.7 mg KOH/g

YAMALUBE® STERNDRIVE DIESEL OIL

Special high-performance engine oil developed for gasoline and diesel-powered inboard engines. Developed, tested and approved by Yamaha.

FEATURES & BENEFITS

- Better cold flow characteristics make for easier engine starting
 - Excellent viscosity stability and reduced friction in all conditions
 - Exceptional anti-wear and anti-corrosion protection that prolongs engine life
 - Good anti-oxidant action and detergency to protect the engine parts and keep them clean
 - Strong dispersancy to keep particles in suspension and prevent the build-up of damaging sludge
- To give your customer the best possible advice, please see the Yamalube® application charts on pages 90-92.

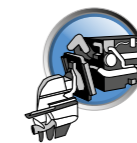

STANDARDS: EQUIVALENT TO API CF SPECIFICATIONS		
Viscosity Grade	SAE	15W-40
Colour	Visual	Brown
Density at 15°C (59°F)	ASTM D1298	0.887 g/cm3
Kinematic viscosity at 100°C (212°F)	ASTM D445	14.7 mm2/s
Viscosity index	ASTM D2270	135
Flash point	ASTM D92	240°C
Pour point	ASTM D97	-32.5°C
Total Base Number	ASTM D2896	11.0 mg KOH/g
Foam sequence II	ASTM D892	20/0 ml max.
Sulphated ash	ASTM D874	1.6 mass %

YAMALUBE® SAE90 GL5 GEAR OIL

This top-performance gear oil was mainly developed to meet the demands of our V8 F350 outboard engine, and is therefore the natural choice for all sterndrive gear cases. Developed, tested and approved by Yamaha.

FEATURES & BENEFITS

Extreme pressure and anti-wear properties give good gear performance under heavy loads and repeated shocks.

Provides very good rust protection against the harsh conditions of the marine environment

High oxidation stability and thermal resistance helps prevent the formation of deposits around seals

Smooth, easy gear shifting is ensured, both at high and low temperatures

Designed to control foaming in the gear case

Retains viscosity and leaves a protective oil film on all surfaces

To give your customer the best possible advice, please see the Yamalube® application charts on pages 90-92.



SPECIFICATIONS

STANDARDS: Equivalent to API GL5 specifications

OIL Grade	SAE90	GL5
Colour	Visual	Brown
Density at 15°C (59°F)	ASTM D1298	0.899 g/cm3
Kinematic viscosity at 100°C (212°F)	ASTM D445	16.55 mm2/s
Viscosity index	ASTM D2270	98
Flash point	ASTM D92	232°C
Pour point	ASTM D97	-18°C
Total Acid Number	ASTM D664	2.23 mg KOH/g
Foam sequence II	ASTM D892	10/0 ml max.

YAMALUBE® SAE90 GL4 GEAR OIL

A premium quality gear oil developed for all outboard gear cases. Developed, tested and approved by Yamaha.

FEATURES & BENEFITS

Better cold flow characteristics ensure easier engine starting

Excellent viscosity stability in use, with reduced friction

Exceptional anti-wear and anti-corrosion protection to prolong engine life

Good anti-oxidant action and detergency to protect engine parts and keep them clean

Strong dispersancy to keep carbon particles in suspension and prevent the build-up of damaging sludge

To give your customer the best possible advice, please see the Yamalube® application charts on pages 90-92.



SPECIFICATIONS

STANDARDS: Equivalent to API CF specifications

OIL Grade	SAE90	GL4
Colour	Visual	Brown
Density at 15°C (59°F)	ASTM D1298	0.895 g/cm3
Kinematic viscosity at 100°C (212°F)	ASTM D445	15.22 mm2/s
Viscosity index	ASTM D2270	97
Flash point	ASTM D92	224°C
Pour point	ASTM D97	-18°C
Total Acid Number	ASTM D664	1.06 mg KOH/g
Foam sequence II	ASTM D892	10/0 ml max.

YAMALUBE® GEAR OIL PUMP

This handy pump makes light work of gearbox oil changes on outboards. Designed to fit the Yamalube® 1 Litre gear oil containers, it comes complete with adapters to fit the gearbox fillers on all Yamaha models, as well as most other leading brands.

FEATURES & BENEFITS

Simple and compact

Easy operation



PACKAGING SIZE	CONTAINER TYPE	PACK LOT	PART NUMBER	PRICE
1 Pcs		1x	YMD-GL4PM-P1-00	

YAMALUBE® LICAL GREASE

Premium multi-purpose grease - combining the advantages of both lithium and calcium - dispersed in highly refined base oils. It contains anti-wear and extreme pressure additives, anti-oxidants and corrosion inhibitors. Developed, tested and approved by Yamaha.

FEATURES & BENEFITS

Mixability with almost all other conventional soap greases

Excellent mechanical stability prevents ejection - or losses of consistency - even under severe operating conditions

Very good pumpability

Does not contain lead or other heavy metals considered harmful to health or the environment

Outstanding water-resistance. In fact, no significant change in performance has been observed, even when this grease has been deliberately contaminated with water

Can help to lower maintenance costs

Equivalent to ISO 6743-9: L-XBDHB 2 and DIN 51 502: KP2K - 25 standards



PACKAGING SIZE	CONTAINER TYPE	PACK LOT	PART NUMBER	PRICE
250 ML	Tube	12x	YMD-69010-0T-A3	
400 GR	Cartridge	1x	YMD-69010-0C-02	

YAMALUBE® CONTACT CLEANER

A non-chlorinated degreasing agent which removes persistent dirt, grease and grime from contacts, electrical systems and spark plugs.

FEATURES & BENEFITS

The exclusive formula replaces standard chlorinate-based cleaners and is therefore less aggressive to some plastics.

APPLICATION

Spray from a short distance directly onto dirty areas

Allow approximately 10 seconds to dry

Finish drying off with a rag or compressed air



PACKAGING SIZE	CONTAINER TYPE	PACK LOT	PART NUMBER	PRICE
400 ML	Aerosol can	12x	YMD-65049-A0-91	

YAMALUBE® CARBURETTOR & INJECTOR CLEANER

A powerful formula, specially developed to eliminate deposits and varnish on butterfly valves, throttle-chambers, nozzles, tanks, floats, and venturi tubes.

FEATURES & BENEFITS

Reduces fuel consumption while increasing engine performance. It also helps the engine idle more evenly and improves acceleration - clean engines last longer too!

APPLICATION

With the engine turned off, disassemble the air filter and spray the Yamalube® Carburettor & Injector Cleaner into the air intake pipe

Leave for 10 minutes

Repeat with the engine on, spraying the product directly onto nozzles, throttle-chambers etc.



PACKAGING SIZE	CONTAINER TYPE	PACK LOT	PART NUMBER	PRICE
400 ML	Aerosol can	12x	YMD-65049-A1-01	

YAMALUBE® PAINT & PLASTIC POLISH

The powered vehicle industry uses more and more high-quality metal, plastic and Perspex parts, treated with different paints, varnish, dyes and finishes. Yamalube® Paint & Plastic Polish restores and maintains a deep gloss on almost any smooth surface.

FEATURES & BENEFITS

Removes fine scratches, treats matt areas and revitalizes colours

Economical - easy to handle and use

Solvent-free

Water-repellent

APPLICATION

Shake well before use. Apply sparingly with a cloth or polishing swab.

Polish off with a soft polishing cloth

For surfaces on motorcycles and scooters, such as:

- Lacquered metal parts (uni-colour, multi-colour, metallic paints)
- Dyed or varnished smooth plastic parts
- Perspex panels
- Helmet visors
- Airbrushed, weathered or refurbished paint
- Painted rims
- Decorative stickers and decals - it will not remove them



PACKAGING SIZE	CONTAINER TYPE	PACK LOT	PART NUMBER	PRICE
220 ML	Aerosol can	12x	YMD-65049-00-61	

YAMALUBE® CLEANING GEL

This cleaning gel is designed for use on all components to remove dirt, grime and grease quickly and efficiently. Its gentle acid and alkaline-free formula ensures that there's no risk of damage or staining.

FEATURES & BENEFITS

Removes the toughest contaminants actively and without residue

Incorporates anti-corrosion additives

Adheres strongly, even to vertical surfaces

Dries without residue and leaves a lasting shine

APPLICATION

Spray the entire vehicle with Yamalube® Cleaning Gel, let it work in for 5 minutes, then rinse down thoroughly with a strong water jet

For extreme contamination (e.g. chain grease or encrusted oil) leave it to work for up to 30 minutes after application before thoroughly rinsing down, until there is no more noticeable foaming - if necessary, a sponge can be used to remove the toughest blemishes or dirt.

Do not use under hot sun or apply to heated surfaces!



TYPE	PACKAGING SIZE	CONTAINER TYPE	PACK LOT	PART NUMBER	PRICE
Pro-Active Cleaning Gel	1 L	Bottle	6x	YMD-65049-00-21	
Pro-Active Cleaning Gel	25 L	Barrel	1x	YMD-65049-00-41	
Tap for 25 L barrel	1 Pcs		3x	YMD-65049-P0-20	

YAMALUBE® PARTS CLEANER

Yamalube® Parts Cleaner is a potent multipurpose degreaser designed to clean and degrease metal parts.

FEATURES & BENEFITS

Brings engine back to its original appearance

Effectively dissolves and removes tar stains, dirty grease, oil, fuel and grime without the need for water

Safe on most rubber, plastic and painted metal surfaces

APPLICATION

Spray 20 cm from the surface

Allow approximately 10 seconds to dry

Respray on very dirty areas



PACKAGING SIZE	CONTAINER TYPE	PACK LOT	PART NUMBER	PRICE
400 ML	Aerosol can	12x	YMD-65049-A0-71	

YAMALUBE® WEATHER PROTECTION SPRAY

Suitable for: Rust and corrosion, caused by wetness and humidity, eat away at metal parts thus reducing its value and appeal. Not many know there is a reliable and effective protection against it. Yamalube® Weather Protection Spray protects and prevents metal parts from corrosion.

FEATURES & BENEFITS

With regular use, reliably protects all metal parts of the vehicle against corrosion and stops existing corrosion in its tracks

Forms a "self-healing", transparent protective film that closes immediately again after being touched, making it better than wax

Perfect for winter lay-up to protect against salt

Lubricates and displaces moisture

APPLICATION

Shake the can before use. Only apply the product to clean, dry surfaces

Spray on the product evenly and sparingly, or apply with a soaked cloth, and wipe down with a soft cloth afterwards. For winter lay-up, spray on generously (without wiping off)

Tip: The product can be easily removed with Yamalube® Cleaning Gel

Note: Do not spray on hot surfaces! Do not spray on brake disks or tyre tread!



PACKAGING SIZE	CONTAINER TYPE	PACK LOT	PART NUMBER	PRICE
300 ML	Aerosol can	6x	YMD-65049-A0-51	

YAMALUBE® SILICON SPRAY

Black engine parts often suffer from dulling as a result of the harsh environment to which they are exposed and especially from the effect of sun-bleaching. Yamalube® Silicon Spray restores and refreshes sun-bleached parts while protecting plastics.

FEATURES & BENEFITS

Yamalube® Silicon Spray serves to optically refurbish:

- Greyed and bleached metal motorcycle parts painted or unpainted (e.g. engine block, frame, fork, engine side covers, rims, etc.)

- Rough and varnished plastic and rubber parts (e.g. side panels, inside panels, mudguards, fixtures, carbon parts, top case, plastic case, blinkers, mirrors, etc.)

APPLICATION

Wash the vehicle thoroughly with Yamalube® Cleaning Gel and then chamois it down

Shake the can well and spray on a thin, even coat from about 20 cm away. Then allow to dry thoroughly

Wipe down any smooth plastic parts, such as linings, with an absorbent cloth after application

Note: To protect surfaces that may not be treated (e.g. tyres, seat, speedometer cover), only apply the product to rims, linings, fittings etc. with a soaked cloth. Do not spray directly onto these parts!



PACKAGING SIZE	CONTAINER TYPE	PACK LOT	PART NUMBER	PRICE
300 ML	Aerosol can	6x	YMD-65049-A0-41	



Application charts for Yamalube® marine products

YAMALUBE® LUBRICANTS FOR: OUTBOARD ENGINES, WAVERUNNERS AND HYDRADRIVE (STERNDRIVE) ENGINES

APPLICATION	SAE	AVAILABLE PACKAGING SIZE	CONTAINER TYPE	PACK LOT	PART NUMBER	PRICE	ON PAGE		
4-S Fully Synthetic Marine Oil									
4-stroke engines	5W-30	1 L	Bottle	12x	YMD-63080-01-00		79		
		4 L	Bottle	4x	YMD-63080-04-00		79		
4-S Super Synthetic Marine Oil									
4-stroke engines	10W-30	1 L	Bottle	12x	YMD-63070-01-00		80		
		4 L	Bottle	4x	YMD-63070-04-00		80		
		60 L	Barrel	1x	YMD-63070-60-00		80		
		200 L	Drum	1x	YMD-63072-08-00		80		
4-S Synthetic Marine Oil									
4-stroke engines	10W-30	1 L	Bottle	12x	YMD-63050-01-00		81		
		4 L	Bottle	4x	YMD-63050-04-00		81		
		60 L	Barrel	1x	YMD-63050-60-00		81		
		200 L	Drum	1x	YMD-63052-20-80		81		
	10W-40	1 L	Bottle	12x	YMD-63060-01-00		81		
		4 L	Bottle	4x	YMD-63060-04-00		81		
		60 L	Barrel	1x	YMD-63060-60-00		81		
		200 L	Drum	1x	YMD-63062-08-00		81		
		2-W engine oil							
		2-stroke engines	NA	1 L	Bottle	12x	YMD-63023-01-00		82
4 L	Bottle			4x	YMD-63023-04-00		82		
2-M Super engine oil									
2-stroke engines	NA	1 L	Bottle	12x	YMD-63021-01-A3		83		
		4 L	Bottle	4x	YMD-63021-04-00		83		
		60 L	Barrel	1x	YMD-63021-60-03		83		
Sterndrive diesel oil									
Sterndrive diesel engines	15W-40	1 L	Bottle	12x	YMD-63042-01-A3		83		
		4 L	Bottle	4x	YMD-63042-04-00		83		
		60 L	Barrel	1x	YMD-63042-60-00		83		
SAE90 GL5 gear oil									
V8 F350 outboard engine & all sterndrive gear cases	NA	1 L	Bottle	12x	YMD-73011-10-03		84		
		20 L	Barrel	1x	YMD-73011-20-03		84		
		60 L	Barrel	1x	YMD-73011-60-02		84		
		200 L	Drum	1x	YMD-73011-20-52		84		
SAE90 GL4 gear oil									
All outboard gear cases	NA	250 ML	Tube	12x	YMD-73010-0T-A3		84		
		1 L	Bottle	12x	YMD-73010-10-A3		84		
		20 L	Barrel	1x	YMD-73010-20-03		84		
		60 L	Barrel	1x	YMD-73010-60-02		84		
		200 L	Drum	1x	YMD-73010-20-52		84		

YAMALUBE® CARELINE

APPLICATION	AVAILABLE PACKAGING SIZE	CONTAINER TYPE	PACK LOT	PART NUMBER	PRICE	ON PAGE
Lical Grease						
Outboard, personal watercraft and inboard gear cases	250 ML	Tube	12x	YMD-69010-0T-A3		85
	400 GR	Cartridge	12x	YMD-69010-0C-02		85
Gear Oil Pump						
1L gear oil containers	1 Pcs		1x	YMD-GL4PM-P1-00		85

YAMALUBE® LUBRICANTS FOR: OUTBOARD ENGINES (BY MODEL)

HP	MODEL	ENGINE OIL				GEAR OIL		
		SAE	YAMALUBE® TYPE	ENGINE OIL CHANGE QUANTITY (LITRE)	SAE	GRADE	LITRE	
4-Stroke								
2.5	F2.5A	10W-30	10W-40	•	0.4	90	GL-4	0.75
4	F4A	10W-30	10W-40	•	0.5	90	GL-4	0.1
4 ~ 6	F4B / F5A / F6C	10W-30	10W-40	•	0.6	90	GL-4	0.1
6 ~ 8	F6B / F8C / F8F / FT8D / FT8G	10W-30	10W-40	•	0.8	90	GL-4	F: 0.15 / FL: 0.37
9.9	F9.9F / FT9.9G	10W-30	10W-40	•	0.8	90	GL-4	F: 0.15 / FL: 0.37
9.9 ~ 15	F9.9C / FT9.9D / F15A / F15B	10W-30	10W-40	•	1.2	90	GL-4	F: 0.25 / FL: 0.37
9.9 ~ 20	F9.9H / F13.5B / F15C / F20B / F20C	10W-30	10W-40	•	1.8	90	GL-4	0.3
20 ~ 25	F20D / F25D / FT25F	10W-30	10W-40	•	1.6	90	GL-4	F: 0.32 / FL: 0.43
30 ~ 40	F30A / F30B / F40B / F40F	10W-30	10W-40	•	1.7	90	GL-4	0.43
30 ~ 40	F30B / F40F	10W-30	10W-40	•	1.7	90	GL-4	0.43
40 ~ 60	F40D / F50F / F50D / FT50C / F60C / FT50G / FT60T	10W-30	10W-40	•	2.1	90	GL-4	F: 0.43 / FL: 0.67
70	F70A	10W-30	10W-40	•	2.1	90	GL-4	0.67
80 ~ 100	F80B / F100D	10W-30	10W-40	•	3.7	90	GL-4	0.67
80 ~ 100	F80C / F100B	10W-30	10W-40	•	3.7	90	GL-4	0.76
115	F115A / FL115A	10W-30	10W-40	•	3.7	90	GL-4	F: 0.76 / FL: 0.72
115	F115B / FL115B / F130A	10W-30	10W-40	•	3.2	90	GL-4	F: 0.76 / FL: 0.72
150	F150A / FL150A / F150D / FL150D	10W-30	10W-40	•	4.7	90	GL-4	F: 0.98 / FL: 0.87
175	F175A	10W-30	10W-40	•	4.5	90	GL-4	0.98
200	F200F / FL200F / F200G / FL200G	10W-30	10W-40	•	4.5	90	GL-4	0.98
200	F200A / FL200A / F200B / FL200B / F200C / FL200C	10W-30	10W-40	•	4.7	90	GL-4	F: 1.15 / FL: 1.0
225	F225A / FL225A / F225B / FL225B	10W-30	10W-40	•	4.7	90	GL-4	F: 1.15 / FL: 1.0
225	F225C	10W-30	10W-40	•	4.7	90	GL-4	0.92
250	F250A / FL250A / F250B / FL250B	10W-30	10W-40	•	4.7	90	GL-4	F: 1.15 / FL: 1.0
225 ~ 300	F225F / FL225F / F250D / FL250D / F300B / FL300B	10W-30	10W-40	•	6.3	90	GL-5	F: 1.04 / FL: 1.0
300 ~ 350	F300A / FL300A / F350A / FL350A	10W-30	10W-40	•	6.5	90	GL-5	F: 1.52 / FL: 1.31
2-Stroke								
4 ~ 5	4A/B/C ~ 5C	TCW3-RL	NA	+	NA	90	GL-4	0.1
6 ~ 8	6C ~ 8C	TCW3-RL	NA	+	NA	90	GL-4	0.16
9.9 ~ 15	9.9D / 9.9F ~ 15D / 15F	TCW3-RL	NA	+	NA	90	GL-4	0.19
20	20C	TCW3-RL	NA	+	NA	90	GL-4	0.18
20 ~ 25	20D ~ 25D	TCW3-RL	NA	+	NA	90	GL-4	0.37
25 ~ 30	25B/X ~ 30H	TCW3-RL	NA	+	NA	90	GL-4	0.32
25 ~ 30	25J ~ 30D	TCW3-RL	NA	+	NA	90	GL-4	0.2
40 ~ 50	40V/X/Y ~ 50H	TCW3-RL	NA	+	NA	90	GL-4	0.43
50 ~ 55	50G ~ 55B	TCW3-RL	NA	+	NA	90	GL-4	0.5
60 ~ 90	60F / 70B / 75A / 80A / 85A / 90A	TCW3-RL	NA	+	NA	90	GL-4	0.61
115 ~ 130	115A ~ 130C	TCW3-RL	NA	+	NA	90	GL-4	0.61
150	150A/F/G/J	TCW3-RL	NA	+	NA	90	GL-4	0.98 / L: 0.87
150 ~ 200	Z150P ~ Z200P	TCW3-RL	NA	+	NA	90	GL-4	Z: 0.98 / LZ: 0.87
175 ~ 200	175A/B/D/F/G/H ~ 200G	TCW3-RL	NA	+	NA	90	GL-4	0.98
200	200A/C/F/H/J	TCW3-RL	NA	+	NA	90	GL-4	0.98 / L: 0.87
200	Z200N / LZ200N	TCW3-RL	NA	+	NA	90	GL-4	Z: 0.98 / LZ: 0.87
200	Z200P/Q	TCW3-RL	NA	+	NA	90	GL-4	0.98
225 ~ 250	225B/C/D/F/G/H ~ 250A/C/D/G	TCW3-RL	NA	+	NA	90	GL-4	1.15 / L: 1.0
250 ~ 300	Z250C/D/F - LZ250C/D/F ~ Z300A/LZ300A	TCW3-RL	NA	+	NA	90	GL-4	Z: 1.15 / LZ: 1.0
300	Z300B	TCW3-RL	NA	+	NA	90	GL-4	1.0

YAMALUBE® LUBRICANTS FOR: WAVERUNNERS

MODEL	ENGINE OIL		ENGINE OIL CHANGE QUANTITY (LITRE)
	SAE	YAMALUBE® OIL TYPE	
4-Stroke			
VX Sport/VX Deluxe/VX Cruiser/V1	10W-30	Synthetic or semi-synthetic engine oil	2.2
FX SHO/FX Cruiser SHO	10W-30	Synthetic or semi-synthetic engine oil	3.1
FX HO/FX Cruiser HO	10W-30	Synthetic or semi-synthetic engine oil	3.1
FZR / FZS	10W-30	Synthetic or semi-synthetic engine oil	3.1
VXS/VXR	10W-30	Synthetic or semi-synthetic engine oil	3.1
FX SVHO/FX Cruiser SVHO	10W-30	Synthetic or semi-synthetic engine oil	3.6
FZR SVHO / FZS SVHO	10W-30	Synthetic or semi-synthetic engine oil	3.6
2-Stroke			
GP1300	NA	2-W engine oil	NA

NEW YAMALUBE LINE-UP CONVERSION TABLE

Old Line Up		New Line Up		
Usage	4- Stroke	Especially good for low/ medium/high HP	Especially good for medium/ high HP	Especially good for high HP
IF USED	Fuel ECO 10W30	UPGRADE TO	Synthetic 10W30	OR Super Synthetic FC-W 10W30
IF USED	Fuel ECO 10W40	UPGRADE TO	Synthetic 10W40	OR Fully Synthetic FC-W 5W30
IF USED	FC-W 10W30	UPGRADE TO	OR Super Synthetic FC-W 10W30	Fully Synthetic FC-W 5W30
IF USED	FC-W 10W40	UPGRADE TO	OR Super Synthetic FC-W 10W30	Fully Synthetic FC-W 5W30

FULLY SYNTHETIC FC-W 5W30

This premium marine engine oil offers excellent fuel economy and extended oil drain intervals, along with ultimate engine cleanliness & protection. Important note: Use this oil only after the running-in period - and for engines with low mileage. As a guide, we recommend you do not use this oil for an engine which is more than 7 years old.



WaveRunner Accessories



FOLDING RE-BOARDING STEP

Provides a wide-step surface for ease of boarding, especially in deep water.

Part Number	Price	Remarks
MWV-FSTEP-VX-11		
MWV-FSTEP-FX-06		NEW 2015
MWV-FSTEP-FZ-09		NEW 2015

FENDER

Engineered specifically for WaveRunners. Easy to hang wherever your craft needs protection.

BLUE	MWV-WVRNR-HH-BL
BLACK	MWV-WVRNR-HH-BK



STORAGE PACK

Need to bring along items that you do not want to move around in the storage compartment or get wet, such as keys, wallets, pagers or cell phones? This pack is your answer.

MWV-BOWPA-CK-00

PULL-UP CLEAT

This pop-up cleat can be easily retrofitted and stows flush to maintain the sleek lines of your WaveRunner. A simple and stylish way to tether your ride.

MWV-PUCLE-AT-07



WAVERUNNER COVERS

These tough, durable covers are specifically designed to fit the sleek curves and powerful shape of your machine – so it looks good even when it's not on the water. The highest quality water-resistant materials are used, so they shrug off the damaging elements and protect your cover against fading and rot.

Important note: During transport, the cover must always be secured with straps running under the watercraft, using the special reinforced eyelets on the cover sides.



Fuel filler access



Eyelet access



Ventilation system

Fuel filler access - The precisely placed zip opening allows easy access to the fuel filler cap without the need to remove the cover.

Eyelet access - The cover allows easy access to the eyelets at the front and stern of the craft for securing with dock lines – or when using tie-down straps for transportation.

Ventilation system - To reduce the risk of humidity formation, these covers have a special ventilation system to allow air to circulate freely around the machine when in storage. The design also helps create a partial vacuum under the cover when moving on a trailer during transport, drawing it more tightly against the hull and topside surfaces.



COVER STORAGE BAG

Yamaha's handy storage bag gives you a place to store your WaveRunner cover neatly while not in use. Made of the same durable material as the Yamaha WaveRunner cover.

MWV-WVRNR-BG-01



FZR SERIES



FZS SERIES



FX SERIES



FX CRUISER SERIES



VXR SERIES



VXS SERIES



VX DELUXE/SPORT SERIES/VX



VX CRUISER SERIES



V1 SERIES



SUPERJET

WAVERUNNER COVERS (2008-2016)

	2016-2015	Price	2014-2012	Price	2011-2008	Price
FZR SERIES	Charcoal/Grey (09-'16) MWV-CVRFZ-GY-15		Charcoal/Grey MWV-CVRFZ-GY-10		Charcoal/Grey ('09-'11) MWV-CVRFZ-GY-10	
FZS SERIES	Black/Grey ('09-'16) MWV-CVRFZ-BG-15		Black/Grey MWV-CVRFZ-BG-10		Black/Grey ('09-'11) MWV-CVRFZ-BG-15	
FX SERIES	Charcoal/Grey (12-'16) MWV-CVRFX-CH-12		Charcoal/Grey MWV-CVRFX-CH-12		Black/Charcoal ('09-'11) MWV-CVRFX-BC-09 Charcoal/Grey ('10-'11) MWV-CVRSH-CG-10 Red Charcoal ('08-'11) MWV-CVRSH-CG-10 Blue Charcoal ('08-'11) MWV-CVRSH-BL-08	
FX CRUISER SERIES	Charcoal/Grey (12-'16) MWV-CVRCR-CH-12		Charcoal/Grey MWV-CVRCR-CH-12		Grey/Black ('09-'11) MWV-CVRFX-GB-09 Grey/Charcoal ('08-'11) MWV-CVRSH-CR-CH	
VXR SERIES	Black/Charcoal MWV-CVRVR-BC-15		Black/Charcoal MWV-CVRVR-BC-11		Black/Charcoal ('11) MWV-CVRVR-BC-11	
VXS SERIES	Black/Charcoal MWV-CVRVS-BC-15		Black/Charcoal MWV-CVRVS-BC-11		Black/Charcoal ('11) MWV-CVRVS-BC-11	
VX DELUXE/SPORT SERIES/VX	Black/Charcoal MWV-CVRVX-BC-15		Black/Charcoal MWV-CVRVX-BC-10		Black/Charcoal ('10-'11) MWV-CVRVX-BC-10	
VX CRUISER SERIES	Black/Charcoal MWV-CVRVX-CR-15		Black/Charcoal MWV-CVRVX-CR-10		Black/Charcoal ('10-'11) MWV-CVRVX-CR-10	
V1 SERIES	Black/Charcoal MWV-CVRV1-CH-15					
SUPERJET	Black MWV-CVRSJ-GY-12		Black MWV-CVRSJ-GY-12		Blue MWV-CVRSJ-BL-08	

BLUE PADDOCK COLLECTION 2016



MEN'S WINDBREAKER

S	B16FJ103E10S	XL	B16FJ103E11L
M	B16FJ103E10M	XXL	B16FJ103E12L
L	B16FJ103E10L	XXXL	B16FJ103E13L



MEN'S JACKET

S	B16FJ104E10S	XL	B16FJ104E11L
M	B16FJ104E10M	XXL	B16FJ104E12L
L	B16FJ104E10L	XXXL	B16FJ104E13L



MEN'S BODYWARMER

S	B16FJ105E10S	XL	B16FJ105E11L
M	B16FJ105E10M	XXL	B16FJ105E12L
L	B16FJ105E10L		



MEN'S LONG SLEEVE

S	B16FT102B90S	XL	B16FT102B91L
M	B16FT102B90M	XXL	B16FT102B92L
L	B16FT102B90L		



MEN'S RELAX PANTS

S	B16FP104B00S	XL	B16FP104B01L
M	B16FP104B00M	XXL	B16FP104B02L
L	B16FP104B00L		



MEN'S FLEECE

S	B16FJ112E10S	XL	B16FJ112E11L
M	B16FJ112E10M	XXL	B16FJ112E12L
L	B16FJ112E10L	XXXL	B16FJ112E13L



MEN'S HOODY

S	B16FT107E10S	XL	B16FT107E11L
M	B16FT107E10M	XXL	B16FT107E12L
L	B16FT107E10L		



MEN'S PIT SHIRT

S	B16FT104E10S	XL	B16FT104E11L
M	B16FT104E10M	XXL	B16FT104E12L
L	B16FT104E10L	XXXL	B16FT104E13L



WOMEN'S SOFTSHELL

XS	B16FJ202B40S	L	B16FJ202B40L
S	B16FJ202B41S	XL	B16FJ202B41L
M	B16FJ202B40M	XXL	B16FJ202B42L



WOMEN'S ZIP SWEAT

XS	B16FT213E11S	L	B16FT213E10L
S	B16FT213E10S	XL	B16FT213E11L
M	B16FT213E10M	XXL	B16FT213E12L



WOMEN'S LONG SLEEVE

XS	B16FT202B91S	L	B16FT202B90L
S	B16FT202B90S	XL	B16FT202B91L
M	B16FT202B90M		



MEN'S POLO

S	B16FT109E10S	XL	B16FT109E11L
M	B16FT109E10M	XXL	B16FT109E12L
L	B16FT109E10L		



MEN'S T-SHIRT

S	B16FT101E10S	XL	B16FT101E11L
M	B16FT101E10M	XXL	B16FT101E12L
L	B16FT101E10L		



MEN'S SOFTSHELL

S	B16FJ102B40S	XL	B16FJ102B41L
M	B16FJ102B40M	XXL	B16FJ102B42L
L	B16FJ102B40L		



WOMEN'S T-SHIRT

XS	B16FT201E10S	L	B16FT201E10L
S	B16FT201E11S	XL	B16FT201E11L
M	B16FT201E10M		



WOMEN'S TANKTOP

XS	B16FT208E11S	L	B16FT208E10L
S	B16FT208E10S	XL	B16FT208E11L
M	B16FT208E10M		

BLUE PADDOCK COLLECTION 2016



JUNIOR'S SOFTSHELL

7-8 years	B16FJ502B412
9-10 years	B16FJ502B414



JUNIOR'S HOODY

7-8 years	B16FT507E112
9-10 years	B16FT507E114



JUNIOR'S T-SHIRT

7-8 years	B16FT501E112
9-10 years	B16FT501E114



JUNIOR'S RELAX PANTS

7-8 years	B16FP504B012
9-10 years	B16FP504B014



KID'S JACKET

1-2 years	B16FJ604E106
3-4 years	B16FJ604E108
5-6 years	B16FJ604E110



KID'S SWEATER

1-2 years	B16FT613E106
3-4 years	B16FT613E108
5-6 years	B16FT613E110



KID'S T-SHIRT

1-2 years	B16FT601E106
3-4 years	B16FT601E108
5-6 years	B16FT601E110



KID'S RELAX PANTS

1-2 years	B16FP604B006
3-4 years	B16FP604B008
5-6 years	B16FP604B010



YOUTH CAP

One size	N16FH400E100
----------	--------------

BLUE PADDOCK COLLECTION 2016



ADULT CAP

One size	N16FH300E100
----------	--------------



BEANIE

One size	N16FH301E100
----------	--------------



TECH 45 RACING WATCH BY TW STEEL

One Size	N13-JW301-M2-45
----------	-----------------



60TH ANNIVERSARY COLLECTION



MEN'S JACKET			
S	B15TJ101Y10S	XL	B15TJ101Y11L
M	B15TJ101Y10M	XXL	B15TJ101Y12L
L	B15TJ101Y10L		



MEN'S SWEAT ZIPPER			
S	B15TJ113B50S	XL	B15TJ113B51L
M	B15TJ113B50M	XXL	B15TJ113B52L
L	B15TJ113B50L		



MEN'S SWEATER			
S	B15TT106Y00S	XL	B15TT106Y01L
M	B15TT106Y00M	XXL	B15TT106Y02L
L	B15TT106Y00L		



WOMEN'S T-SHIRT YELLOW-WHITE			
XS	B15TT201Y21S	L	B15TT201Y20L
S	B15TT201Y20S	XL	B15TT201Y21L
M	B15TT201Y20M		



WOMEN'S HOODY			
XS	B15TT207B51S	L	B15TT207B50L
S	B15TT207B50S	XL	B15TT207B51L
M	B15TT207B50M		



WOMEN'S BLACK POLO			
XS	B15TT209B51S	L	B15TT209B50L
S	B15TT209B50S	XL	B15TT209B51L
M	B15TT209B50M		



MEN'S WHITE POLO			
S	B15TT109Y20S	XL	B15TT109Y21L
M	B15TT109Y20M	XXL	B15TT109Y22L
L	B15TT109Y20L		



MEN'S BLACK POLO			
S	B15TT109B50S	XL	B15TT109B51L
M	B15TT109B50M	XXL	B15TT109B52L
L	B15TT109B50L		



MEN'S LONG SLEEVE			
S	B15TT102Y10S	XL	B15TT102Y11L
M	B15TT102Y10M	XXL	B15TT102Y12L
L	B15TT102Y10L		



KIDS SWEATER			
1-2 years	B15TT606Y206	7-8 years	B15TT606Y212
3-4 years	B15TT606Y208		
5-6 years	B15TT606Y210		



KIDS T-SHIRT			
1-2 years	B15TT601Y206	7-8 years	B15TT601Y212
3-4 years	B15TT601Y208		
5-6 years	B15TT601Y210		



CAP (BLACK)	
One size	N15TH000B500



MEN'S T-SHIRT YELLOW-WHITE			
S	B15TT101Y20S	XL	B15TT101Y21L
M	B15TT101Y20M	XXL	B15TT101Y22L
L	B15TT101Y20L		



MEN'S T-SHIRT YELLOW-BLACK			
S	B15TT101Y10S	XL	B15TT101Y11L
M	B15TT101Y10M	XXL	B15TT101Y12L
L	B15TT101Y10L		



WOMEN'S JACKET			
XS	B15TH201Y11S	L	B15TH201Y10L
S	B15TH201Y10S	XL	B15TH201Y11L
M	B15TH201Y10M		



CAP (YELLOW/WHITE)	
One size	N15TH000Y200



60TH ANNIVERSARY COLLECTION



BUSINESS FOLDER

N15TE006B000



BACK PACK

T15TB001B500



A5 NOTE BOOK

N15TE000B500



RACING TABLET BAG

Dim: 19 x 25 x 4 cm T14-JB005-00-E2



RACING LEVEL 1 BACK PACK

Dim: 48 x 30 x 14 cm T14-JB001-00-E2



RACING LEVEL 2 BACK PACK

Dim: 42 x 28 x 10 cm T14-JA002-00-E2



FOUNTAIN PEN

N15TE003Y100



RESIN STICKER

N15TK009Y200



ENAMEL MUG

N15TD002Y200



RACING KIDS BACK PACK

Dim: 30 x 21 x 16 cm T14-JB601-00-E2



FLOATING INFLATABLE COOLER

One size MAR-FLTCL-ER-06



SEW ON BADGE

N15TA007Y200



KEYRING

N15TK003Y100



WATCH

N15TW001B500



RACING GEAR BAG

Dim: 47 x 45 x 80 cm T14-JA001-00-E2



RACING SPORTS BAG

Dim: 29 x 50-64 x 26 cm T14-JB008-00-E2



RACING HELMET BAG

Dim: 32 x 28 x 41 cm T14-JA003-00-E2



1 - YMH BTB LAPTOP BAG

Dim: 34 x 42 x 11 cm T13-BC004-00-B1

2 - YMH BTB CABIN TROLLEY

Dim: 50 x 37 x 25 cm T13-BC006-00-B1

3 - YMH BTB LAPTOP TROLLEY

Dim: 40 x 42 x 25 cm T13-BC005-00-B1



ILONA WHITE ORIGINAL MUG
N08-6G080-00-0A

BLUE TUNING FORK MUG
N08-6G030-00-4A



TF KEYCHAIN
YMD-10070-10-10

YMH LEATHER WALLET
N13-NC100-B0-00



TUNING FORK WALL CLOCK
N12-NC006-00-M2

YMH MEMORY GAME
N13-NP005-C0-00



PEN SET
N15-NC002-00-B0

TF CUFF LINKS
N11-NA002-00-M1



WRIST WATCH TW STEEL TECH 45
N13-JW301-M2-45

WRIST WATCH TW STEEL TECH 48
N13-JW301-M2-48



WRIST WATCH TW STEEL PILOT 45
N13-JW301-M3-45

WRIST WATCH TW STEEL PILOT 48
N13-JW301-M3-48



RACING WATCH BY TW STEEL

Blue - Size 40mm	N15-JW001-E0-40
Blue - Size 45mm	N15-JW001-E0-45
Black - Size 40mm	N15-JW001-B0-40
Black - Size 45mm	N15-JW001-B0-45
White - Size 40mm	N15-JW001-W0-40
White - Size 45mm	N15-JW001-W0-45
MOVISTAR Green - Size 40mm	N15-JW001-G1-40
MOVISTAR Green - Size 45mm	N15-JW001-G1-45
Antique Yellow - Size 40mm	N15-JW001-Y0-40
Antique Yellow - Size 45mm	N15-JW001-Y0-45
Grey - Size 40mm	N15-JW001-F0-40
Grey - Size 45mm	N15-JW001-F0-45



YMH SUNGLASSES ADVENTURE
N13-NA304-00-B0



YMH SUNGLASSES LEISURE
N13-NA305-00-B0



350 OUTBOARD FLOATING KEYCHAIN
N13-NK001-00-F0



TF PVC KEYCHAIN
Blue N08-6A030-00-4A
Red N08-6A0C0-00-3A

YAMAHA VELCRO WALLET
N11-NC001-00-B0



YAMAHA RACING VELCRO WALLET
N11-NC001-00-E0



GOLF BALLS
N14-NP001-00-C0



YAMAHA THERMAL FLASK
N13-NR004-00-M2

YMH RACING BEACH TOWEL
N13-NR001-00-E0



YAMAHA BEACH BALL
N14-NR002-00-E0



BEACH TENNIS SET
N14-NR008-00-E0



FIRST AID KIT
N14-NB001-00-B0



KIDS BODYBOARD
39" N14-MP612-00-E2



YMH PIT CHAIR
N13-NP010-00-E0



FLIP FLOP BLACK

36	N11-NF302-36-B0
38	N11-NF302-38-B0
40	N11-NF302-40-B0
42	N11-NF302-42-B0
44	N11-NF302-44-B0
46	N11-NF302-46-B0



FLIP FLOP BLUE

36	N11-NF302-36-E0
38	N11-NF302-38-E0
40	N11-NF302-40-E0
42	N11-NF302-42-E0
44	N11-NF302-44-E0
46	N11-NF302-46-E0

KANDO WETSUITS



MEN'S SHORTY

Shorty with great flex and a partially soft and warm thermo liner on the inside. 2.5mm Neoprene on the chest and back. 2mm on legs and arms. Comfortable stitch construction that is soft on bare skin and super strong. Hydrophobic Skin panels on the outside of the suit jacket, strategically positioned to help maintain warmth and repel water. Back Zipper. Flex panels for optimal flexibility and comfort. Rolled seals are tight to keep cold water out and warm water in.

S	D16LW001B60S	XL	D16LW001B61L
M	D16LW001B60M	XXL	D16LW001B62L
L	D16LW001B60L		



MEN'S KANDO VEST

Made with the softest, most comfortable neoprene around... The Kando male vest comes outfitted with a front zipper, dual buckles and a custom water drain system. 50N ISO Approved floating device. CE Approved according to ISO 12402.5. YKK Front Zip: to easily get the vest on and off. Soft Neoprene fabric that provides maximum comfort. PVC Foam: Soft and comfortable foam that gives you the buoyancy that is needed. D-Ring: Attachment for emergency cord. WDS: Water drain system; Makes sure that the vest drains all the water quickly thereby drying even faster.

S	D16LV001B60S	XL	D16LV001B61L
M	D16LV001B60M	XXL	D16LV001B62L
L	D16LV001B60L		



MEN'S FULL SUIT

Excellent all around wetsuit with great flex and a partially soft and warm thermo liner on the inside. 3.0mm neoprene on the chest and backs. Legs and arms are 2.5mm. Knee panels are covered with bombproof Ink for extra protection. Comfortable stitch construction that is soft on bare skin and super strong. Hydrophobic Skin panels on the outside of the suit jacket, strategically positioned to help maintain warmth and repel water. Back Zipper. Flex panels for optimal flexibility and comfort. Rolled seals are tight to keep cold water out and warm water in.

S	D16LW011B60S	XL	D16LW011B61L
M	D16LW011B60M	XXL	D16LW011B62L
L	D16LW011B60L		



MEN'S LONGJOHN AND JACKET

This LongJohn jacket is outfitted with a short spandex sleeve. 2.0 for those not so freezing days. It's simply THE choice for all you PWC fanatics out there! This Long John/jacket is made completely out of 2.0mm Neoprene. Hydrophobic Skin panels on the outside of the suit jacket, strategically positioned to help maintain warmth and repel water. Comfortable stitch construction that is soft on bare skin and super strong. Glide skins: Both comfortable and soft, they prevent water from coming in and out. Knee panels are covered with bombproof Ink for extra protection.

S	D16LW021B60S	XL	D16LW021B61L
M	D16LW021B60M	XXL	D16LW021B62L
L	D16LW021B60L	XXXL	D16LW021B63L



WOMEN'S SHORTY

Affordable shorty with great flex and partially soft and warm thermo liner .2.5mm Neoprene on the chest and back. 2mm on legs and arms. Comfortable stitch construction that is soft on bare skin and super strong. Hydrophobic Skin panels on the outside of the suit jacket, strategically positioned to help maintain warmth and repel water. Back Zipper. Gymnast construction is as flexible as you can get. Large one-piece panels and minimum use of seams to give the ultimate in flex and comfort. Flex panels for optimal flexibility and comfort. Rolled seals are tight to keep cold water out and warm water in.

S	D16LW002B40S	L	D16LW002B40L
M	D16LW002B40M	XL	D16LW002B41L



WOMEN'S KANDO VEST

The Kando Female vest features a segmented back panel for extra range in motion. Outfitted with an integrated webbing design, which hides the webbing straps for more safety. 50N ISO Approved floating device. CE Approved according to ISO 12402.5. YKK Front Zip: to easily get the vest on and off. PVC/PE Foam: Front panels use PVC foam; the panels on the back are made out of PE foam .D-Ring: Attachment for emergency cord. 3-D Fabric, Provides the already amazing comfort of neoprene, while absorbing less water. It's super light and fast-drying. Integrated webbing. Completely or partly hidden webbing straps for more safety and better look. WDS: Water drain system; Makes sure that the vest drains all the water quickly thereby drying even faster.

S	D16LV002B40S	XL	D16LV002B41L
M	D16LV002B40M	XXL	D16LV002B42L
L	D16LV002B40L		



WAVERUNNER 4 BUCKLE VEST

These vests are made with soft PVC foam that's comfortable and provides the buoyancy needed. Extra foam panels on the side give additional protection. 50N ISO Approved floating device. CE Approved according to ISO 12402.5.

Nylon fabric: Makes the vest lightweight and provides lightening fast drying time.

PVC Foam: Soft and comfortable foam that gives you the buoyancy that is needed. Extra foam panels at the side of the vest that gives additional protection.

D-Ring: Attachment for emergency cord.

WDS: Water drain system - Makes sure that the vest drains all the water quickly thereby drying even faster.

Orange Vest:

XS	D16LV401B61S	XL	D16LV401B61L
S	D16LV401B60S	XXL	D16LV401B62L
M	D16LV401B60M	XXXL	D16LV401B63L
L	D16LV401B60L		

Blue Vest

XS	D16LV401B41S	XL	D16LV401B41L
S	D16LV401B40S	XXL	D16LV401B42L
M	D16LV401B40M	XXXL	D16LV401B43L
L	D16LV401B40L		



WAVERUNNER UNIVERSAL VEST

Basic but reliable nylon vest. One size fits all. 50N ISO Approved floating device. CE Approved according to ISO 12402.5. Nylon fabric. Makes the vest lightweight and provides lightening fast drying time. PE Foam: Light foam that is made out of different layers of foam.

One size	D16LV000B400
----------	--------------



NEOPRENE JACKET

This jacket is made with the softest 1.5 mm neoprene, providing you with maximum comfort and warmth! Mesh panels on the outside of the jacket are water-repellent and therefore, it keeps the body heat in and the water out. With thermos lining to give additional warmth and better comfort. Flat lock: comfortable flat stitch construction that is soft to the bare skin and super strong.

S	D16LVJ00B00S	L	D16LVJ00B00L
M	D16LVJ00B00M	XL	D16LVJ00B01L

WAVERUNNER GLOVES

These Yamaha WaveRunner gloves give you for more freedom of movement and feature a segmented finger design. They come outfitted with padded panels and nonslip Amara.

XS	D16KG033B01S	L	D16KG033B00L
S	D16KG033B00S	XL	D16KG033B01L
M	D16KG033B00M	XXL	D16KG033B02L

WAVERUNNER BEACH SHOES

These water shoes come with comfortable rigid soles and the water flows easily in and out of the shoes. 2.0mm Neoprene fabric with reinforced soles, ideal for all water activities. Comfortable and warm with breathing airprene fabric for extra ventilation.

Part Number	Yam Code	EU size	USA size	UK size
D16KF013B004	4	36	4,5	4
D16KF013B005	5	37	5,5	5
D16KF013B006	6	38	6	5,5
D16KF013B007	7	39	6,5-7	6
D16KF013B008	8	40-41	7-8	6-7
D16KF013B009	9	42-43	8,5-9,5	7,5-8,5
D16KF013B010	10	44	10	9
D16KF013B011	11	45	11	10
D16KF013B012	12	46	12	11
D16KF013B013	13	47	13	12



FUNTUBE

Let's get ready to ruumble!!! Get it ON with the 1-person Rumble towable! Made of 420 Denier Heavy-duty Nylon. Inner is made with 24G PVC. 4 handles. 1 water drain to ensure good water release from the inside of the nylon cover. On way Boston valve with 2 caps. Screw off the top cap and the valve lets air in but no air out for easy inflation. Screw off the second cap for quick deflation. Safety chamber.

Funtube	YMM16T0100E0
---------	--------------



SHUTTLE

Time to start tubing! This three handle towable is a great ride! Made of 840 Denier Heavy-duty Nylon. Inner is made with 30G PVC. 3 handles. 3 water drain to ensure good water release from the inside of the nylon cover. One-way Boston valve with 2 caps. Screw off the top cap and the valve lets air in but no air out for easy inflation. Screw off the second cap for quick deflation. Safety chamber.

Shuttle	YMM16T0500E0
---------	--------------



TOW ROPE

Towrope made for 4-person towables max.

4-person Tow Rope	YMM16A0100E0
-------------------	--------------



AQUAZOOKA

Dip into the water, pull back the handle to siphon water up into the Aquazooka barrel and push on the handle to fire up 50 meters.

Single Barrel	SBTYAZ18R013
Double Barrel	SBTYAZ18DS14

WETSUITS MEN	EU SIZE	LENGHT CM	CHEST CM	WAIST CM
XS	46	163 - 171	86 - 94	66 - 76
S	48	170 - 177	88 - 97	69 - 79
M	50	174 - 180	93 - 100	74 - 84
L	52	180 - 186	97 - 104	76 - 86
XL	54	186 - 192	98 - 105	79 - 89
2XL	56	188 - 194	104 - 110	84 - 94
3XL	58	192 - 197	109 - 115	86 - 96

WETSUITS WOMEN	EU SIZE	LENGHT CM	CHEST CM	WAIST CM
XS	34	158 - 170	72 - 80	60 - 68
S	36	160 - 172	77 - 86	62 - 74
M	38	162 - 176	82 - 90	65 - 77
L	40	168 - 180	84 - 92	69 - 79
XL	42	172 - 182	90 - 98	72 - 80
2XL	44	174 - 184	96 - 102	76 - 85

KANDO MEN VEST	S	M	L	XL	2XL	3XL
CHEST CM	80 - 90	90 - 100	100 - 110	110 - 120	120 - 130	130 - 140
WEIGHT KG	50 - 60	> 60	>70	>70	>70	>70

4 BUCKLES VEST	S	M	L	XL	2XL	3XL
CHEST CM	80 - 90	80 -100	90 - 100	100 - 110	110 +	120 +
WEIGHT KG	50 - 60	60 - 70	> 70	> 70	> 70	> 70

UNIVERSAL VEST	Univ.
CHEST CM	73 - 130
WEIGHT KG	40 - 100

KANDO WOMEN VEST	XS	S	M	L	XL
CHEST CM	76 - 83	83 - 91	91 - 99	99 - 106	106 - 114
WEIGHT KG	30 - 50	40 - 60	50 - 70	60 - 80	> 70

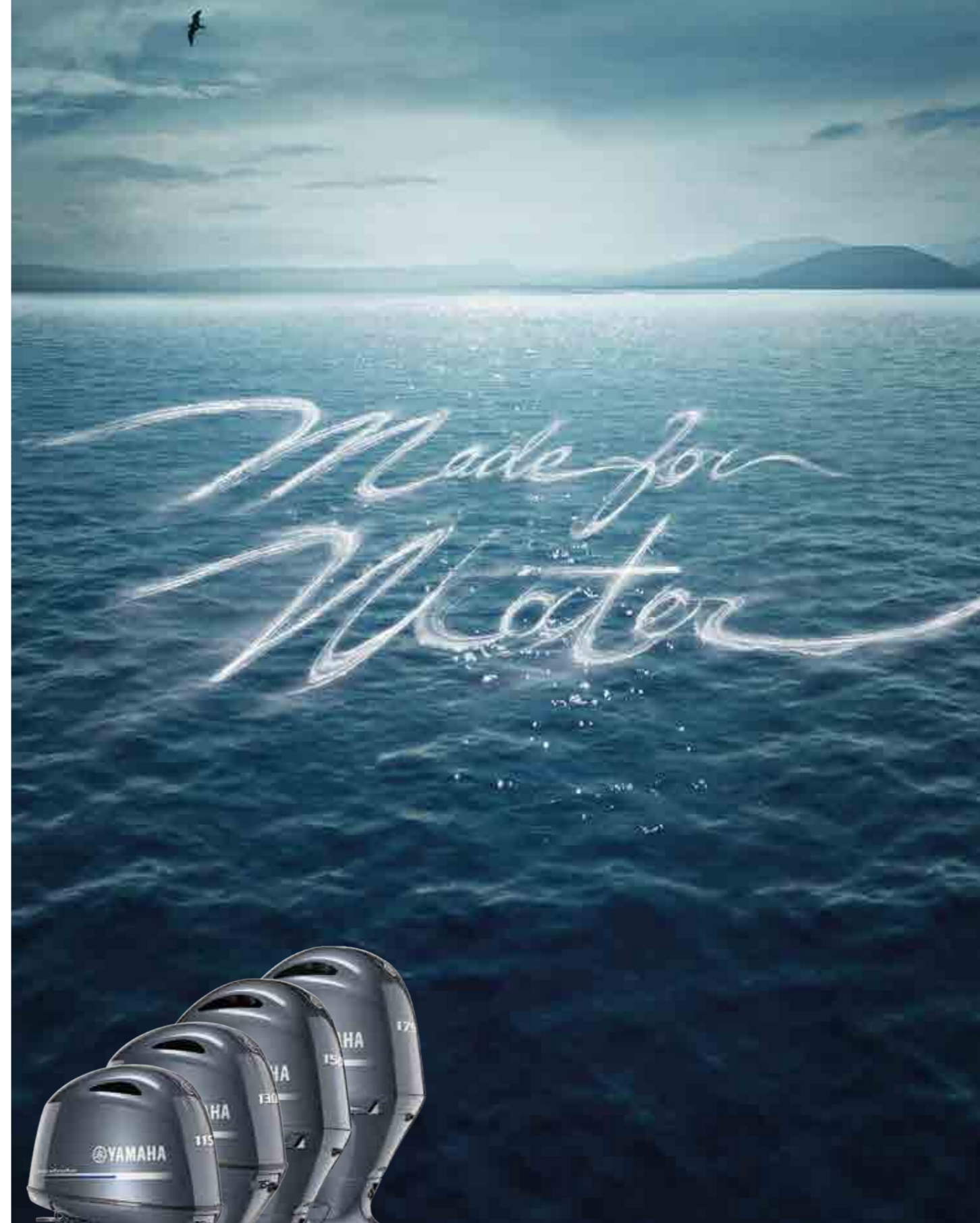

By the sheer excellence of its engines, Yamaha Marine continues to confirm its leadership on the water. From the smallest up to the most powerful, our wide range of outboards offers you new experiences - whether you like heading out to the open sea to allow your emotions more space, or enjoy the adrenaline rush of conquering the waves or you simply want to get around on the water in the most efficient, practical way. Whatever your course or destination, if you're made for the water, Yamaha Marine is made for you. **Yamaha Marine. Made for water.**



www.yamaha-motor.eu



www.yamaha-motor.eu

Disclaimer

All information in this catalogue is given for general guidance only and is subject to change without prior notice. Always wear the recommended personal floatation device and safety equipment while boating. Yamaha encourages you to navigate safely, to respect fellow water users and the environment. Images may show boats being driven by professionals and no recommendation or guidance in respect of safe operation or style of use is intended or implied by the publication of these images. The boats and Yamaha outboard engines displayed on the images may be equipped with genuine Yamaha rigging accessories. Specifications and appearance of Yamaha products, Yamaha accessories and non Yamaha branded accessories are subject to change without prior notice. Non Yamaha branded accessories are fully developed and produced by respected third parties. Yamaha does not guarantee the availability of the displayed products and accessories in local markets. The product and accessories range may be limited in some countries. Yamaha has the right to discontinue products and accessories without prior notice. Where applicable, prices of Yamaha products and accessories may vary according to local requirements and conditions. No rights can be obtained from this information. For further details and availability, please contact your local Yamaha dealer.



Yamaha highly recommend the use of genuine Yamaha accessories and clothing. Contact your local dealer or visit our website:
www.yamaha-motor.eu

Yamaha Motor Europe N.V.
Koolhovenlaan 101
P.O. Box 75033
1117 ZN Schiphol
The Netherlands